

Analysis of Chemical Markers in Adulterated Fuels using a Transportable Ultrafast Micro Gas Chromatograph

Jeremy Reyes*; Bill Winniford; Brian Jazdzewski;
Warren Smith; Zahid Asif; Molly Price
The Dow Chemical Company

John Crandall; Ned Roques; Spencer Parker; Joe Perron; Matt Holliday
Falcon Analytical Systems and Technology, LLC



Talk Overview

- ❑ Fuel Markers
 - ❑ Introduction
 - ❑ Defining the Problem: Branded Fuel; Tax Rebated Fuel
 - ❑ Fuel Fraud/Laundering Examples
- ❑ Detection of ACCUTRACE™ S10 using CALIDUS™ ultrafast Micro GC
 - ❑ ACCUTRACE™ S10 offering and key benefits
 - ❑ Heartcut 2D-GC Method
 - ❑ Implementation in the UK and Ireland
- ❑ Summary



Dow Fuel Marking: Usage, History, and Value

❑ Usage

- Fuel markers are used by government agencies and fuel marketers to differentiate fuel sources
- Helps prevent illegal laundering of tax-rebated fuels and use of fuels in unsanctioned applications

❑ Value

- Global fuel dyes and markers market estimated at \$342 MM by 2019
- In 2013 UK and Ireland lost an estimated 1.7 billion of tax revenue as a result of illegal fuel laundering activities

❑ Current Dow Marking Products

- AUTOMATE™ and MORTRACE™ colored fuel dyes
- SPECTRACE™ digital fuel markers
- ACCUTRACE™ launder resistant forensic fuel markers



Dow Fuel Marking: A history of technology



The Problem: Fuel Laundering / Fuel Fraud

Branded Fuel Marketing

- ❑ unscrupulous dealers substituting all or part of branded fuel with adulterant(s)
 - left unchecked, losses to adulteration are estimated to fall between 5 and 20% of a retailer's branded fuel volume
 - one bad experience with adulterated fuel can turn away the most brand loyal of consumers for a lifetime
 - vehicle engines and emission systems are not designed to handle poor quality, adulterated fuel and cause substantial harm to the community
 - examples (generic fuel into branded fuel; spent solvent into branded fuel ;octane cheating)

Government Fuel Taxes

- ❑ criminals obtain tax free (low tax) fuel and add this into tax paid (high tax) fuels
 - left unchecked, losses to adulteration are estimated to fall between 5 and 20% of a retailer's branded fuel volume
 - one bad experience with adulterated fuel can turn away the most brand loyal of consumers for a lifetime
 - vehicle engines and emission systems are not designed to handle poor quality, adulterated fuel and cause substantial harm to the community
 - examples (Home Heating Fuel into DIESEL; Export fuel illegally; Kerosene into Gasoline)



Fuel Fraud in Saudi Arabia

Ring of diesel smugglers busted

“Smugglers traffic in diesel fuel, which is usually loaded into fuel trucks. They claim that they are transporting used engine oil. They mix the used oil with diesel fuel and export it to Asian countries like India and the Philippines. Unfortunately, this mixture is sold on the international market as genuine oil, whereas in fact, more than 90 percent of it is diesel. Once the shipment arrives in India, they separate the used engine oil from diesel and sell it as pure diesel. The price of diesel India is 10 times the price in Saudi Arabia,” he said.

Abusing subsidy, diesel smugglers go full blast at KSA-UAE border

Diesel smugglers in the Kingdom continue to rake in the moolah taking advantage of the government subsidy on the fuel with 10,000 liters on average crossing the Saudi borders every day.

This despite the all out efforts by authorities to rein in diesel smuggling evident from the fact that 8 million liters of the fuel had been seized by Saudi Customs in 2013. The destination is invariably the northern areas of the UAE because of the huge cost differential.

Compare this — a liter of diesel costs just 25 halalas per liter while it costs over SR3.70 in the UAE! A tanker of diesel, which costs SR8,000 in the Kingdom, fetches SR100,000 when it crosses over to the UAE, a neat profit of SR92,000 minus of

<http://www.emirates247.com/business/energy/diesel-smuggling-from-saudi-continues-2010-08-23-1.282608>
<http://www.arabnews.com/node/582656> <http://www.arabnews.com/news/543606>



Fuel Laundering Examples (UK/Ireland)



- **Republic of Ireland (March 2013)**
 - laundering by bleaching agent
 - 19 premises in 10 counties
 - 10 million liters of diesel/year
 - €5.5 million loss in tax revenue
 - 25 bank accounts frozen



- **UK (March 2011)**
 - laundering by acid treatment
 - industrial scale plant (Crossmaglen)
 - >30 million liters of fuel/year
 - £20 MM million loss in tax revenue

<http://www.emirates247.com/business/energy/diesel-smuggling-from-saudi-continues-2010-08-23-1.282608>
<http://www.arabnews.com/node/582656> <http://www.arabnews.com/news/543606>



❑ Secure

- proprietary and unique
- custom designed, novel chemistry
- patent pending in many Countries
- marker formula's are custom made and identities kept secret

❑ Robust

- not prone to degradation or interference from other marker systems

❑ Admissible

- in a court of law

ACCUTRACE™ provides you a secure solution – unique, robust, and admissible

ACCUTRACE™ S10: Key Benefits

- ❑ most resistant to all known criminal removal techniques
- ❑ highly cost effective in deterring fuel laundering, which funds criminal activity and results in environmentally hazardous waste dumping
- ❑ introduces no known ozone-depleting additives as it is made of same elements as fuel itself
- ❑ invisible to the eye and difficult for criminals to discover but readily detectable by law enforcement using highly accurate and mobile testing methods



Heartcut 2D GC Method

- ❑ 2D GC with heartcutting capability using a Deans switch allows separation of components that are unresolved on the primary column
- ❑ avoids false positives due to co-elution of other components present in the fuel matrices.
- ❑ *heartcut 2D GC identified as method of choice for detection and quantification.*

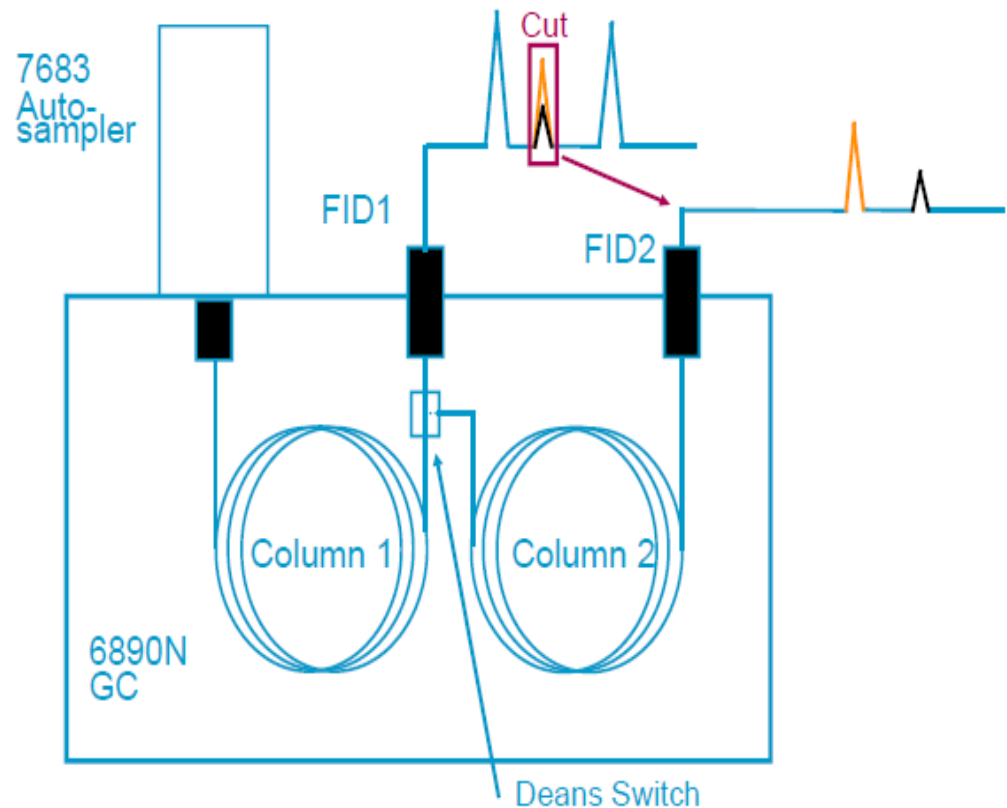

<https://www.chem.agilent.com/Library/eseminars/Public/Deans%20Switch%20060711.pdf>

CALIDUS™ CS, for roadside analysis of ACCUTRACE™

- ☐ highly transportable
 - ~11 kilograms
 - < 300 Watts
 - ~ 17 x 8.5 x 11 inches
- ☐ economic
 - lowest capital
 - lowest consumables
- ☐ highest Durability
 - field proven
 - industry standard FIDs
 - temperatures well below spec limit on the CS valve

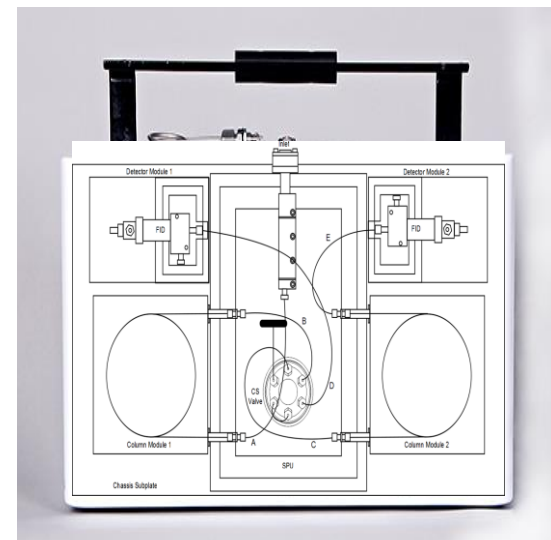
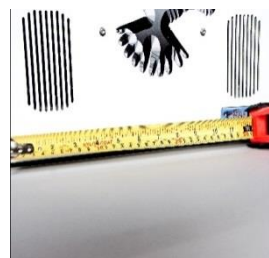
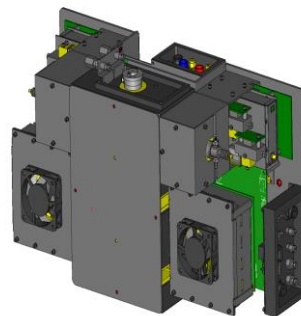

CALIDUS™ CS Instrument Layout

Columns and Detector

- relatively non-polar column on Channel 1
- relatively polar column on Channel 2
- rugged, reliable, industry standard FID detectors
 - FID 1 used to determine heartcut timing and normalization of results
 - FID 2 used to measure ACCUTRACE™ S10

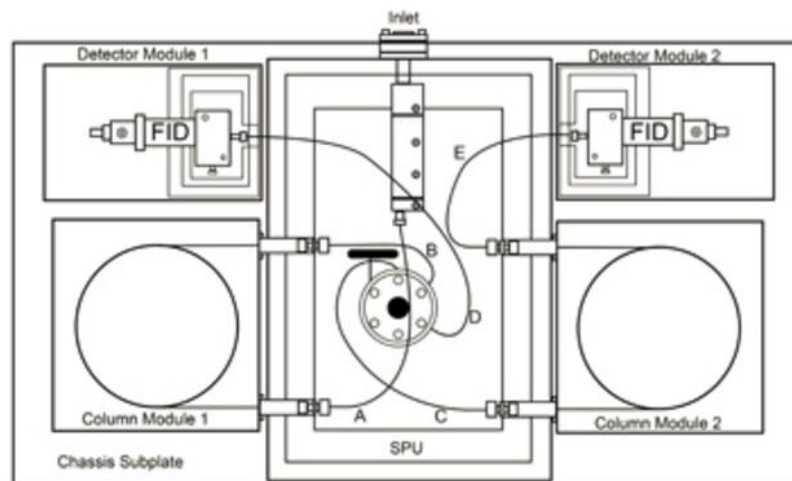

CS Valve for Heartcut

- high temperature rotary valve with pneumatic actuation
- special temperature control employed on valve body
- temperature well below the specification limit for the valve



Resistively heated column modules

Calibration Standard on Separation Channel 1

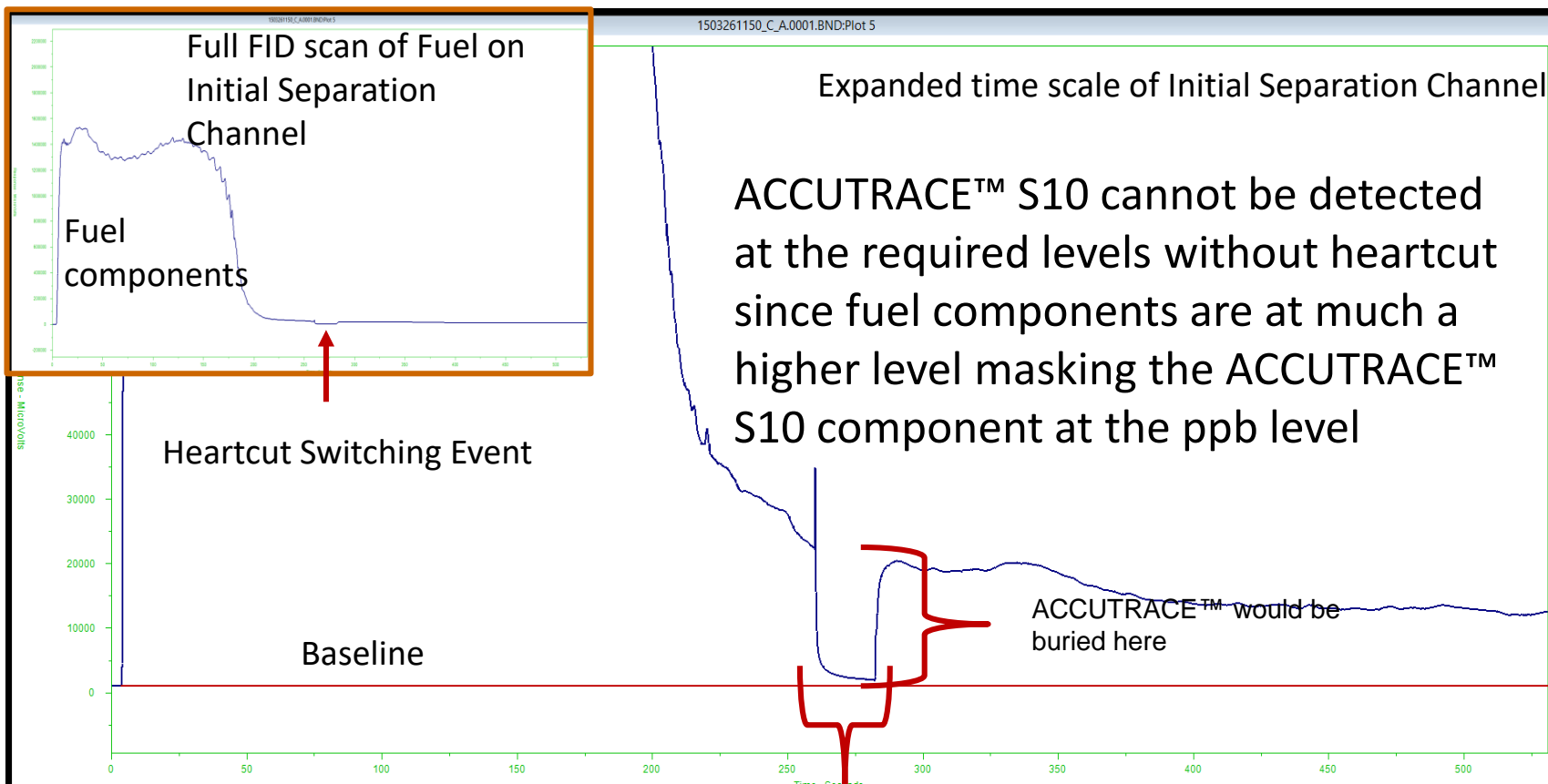

Expanded time scale of Initial Separation Channel

ACCUTRACE™ S10 cannot be detected at the required levels without heartcut since fuel components are at much a higher level masking the ACCUTRACE™ S10 component at the ppb level

Material Heartcut into MXT-50 including ACCUTRACE™ S10

Calibration Standard on Heartcut Channel 2

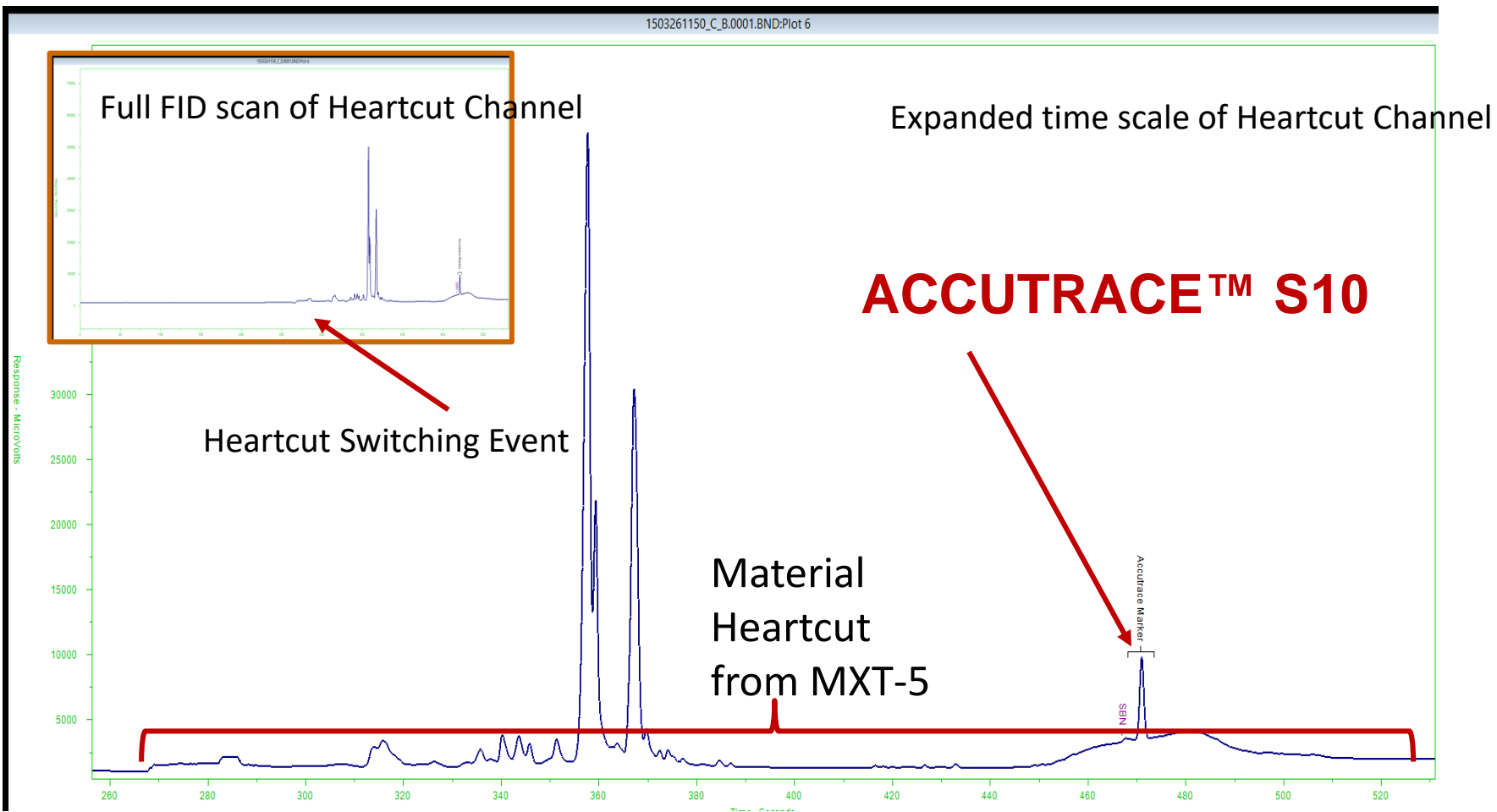

<https://www.chem.agilent.com/Library/eseminars/Public/Deans%20Switch%20060711.pdf>



Linearity / LOD, LOQ

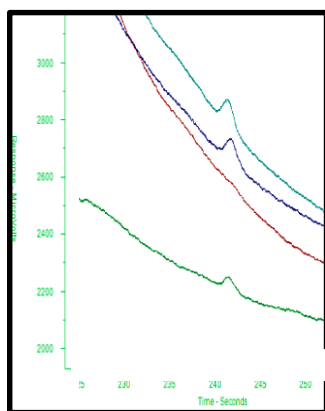
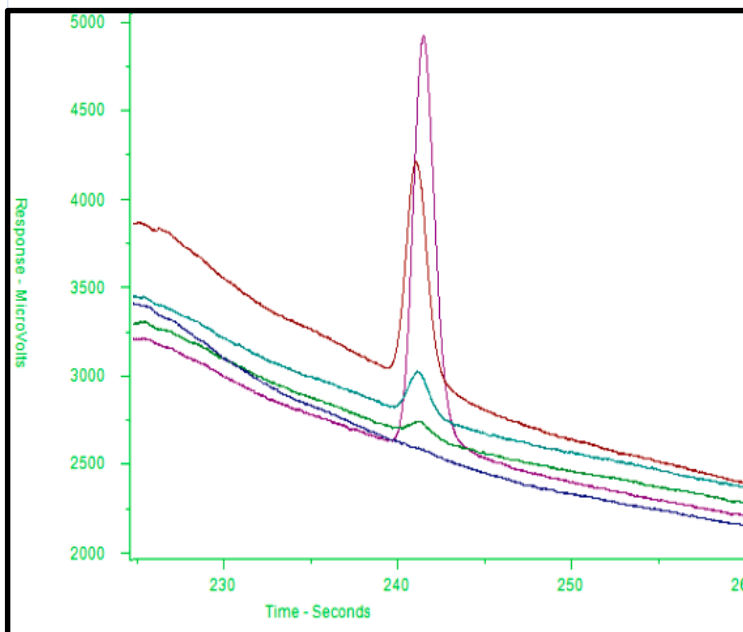

Triplicate injections at 49 µg/L (overlaid with unmarked diesel; red trace)

ACCUTRACE™ S10 in diesel

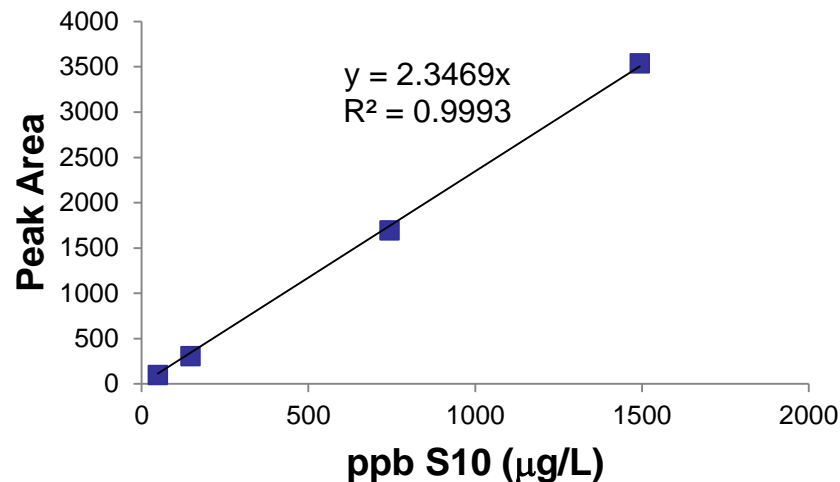

LOD ppb (µg/L)	19
LOQ ppb (µg/L)	63
LOQ equivalent to dosage rate	0.63%

- ACCUTRACE™ S10 – quantifiable down to 63 ppb (µg/L).
- Setting a trigger at 125 ppb and a tolerance value insures no false negatives and no false positives.

Implementation in the Field (UK/Ireland)

Fuel Marker Demonstrates Success in United Kingdom & Ireland

Governments Report Progress in Fight Against Fuel Laundering



David Ford, Justice Minister for Northern Ireland, checks out the mobile GC system

"Since the launch of the new marker we have seen a **significant reduction** in the detection of laundering plants and dumping of waste material associated with laundering activities."

- Pat Curtis¹⁰

National Oils Lead Investigator, HMRC

- ❑ in the first six months, HMRC has undertaken 26,261 tests with 1,299 detections made.
- ❑ 85 cases identified where ACCUTRACE™ S10 was present with low levels of 'old style' markers (indication of laundering attempts)
- ❑ increased fuel sales of legitimate diesel by 2.1% (1Q 2014) and 5.9% (1Q 2015).
- ❑ fuel duty on legitimate diesel increased by £310 million in the first 3 months of use as illegal fuel launderers ceased or decreased their operations.

<http://msdssearch.dow.com/PublishedLiteratureDOWCOM>

<http://www.ima.co.uk/system/images/1089/original/30-03-16-pr-march-16-new-gas-chromatograph>

DOW

®

Hu
12.000

Summary

- ❑ A robust 2D-GC heartcut portable detection method was developed to distinguish marker from fuel matrix.
- ❑ ACCUTRACE™ S10 currently used in marking tax rebated fuels in UK and Ireland with successful implementation of CALIDUS™ ultrafast GC in the field.
- ❑ Evaluation report by HMRC and IGEES showed that the use of Dow's ACCUTRACE™ S10 Marker has led to:
 - reduction in laundering plants discovered; a decline in illegal use of subsidized fuels; a drop in waste products associated with fuel laundering.
 - negligible selling of laundered fuel and the problem is close to being eliminated.
- ❑ Dow's ACCUTRACE™ fuel marking technology is a finalist for the:
 - 2016 R&D 100 Awards
 - 2016 IChemE Global Awards (Innovative Product Award)



Backup Slides

<https://www.chem.agilent.com/Library/eseminars/Public/Deans%20Switch%20060711.pdf>



Mobile Ultrafast Gas Chromatography Laboratory



Late Summer Demonstration Tour

- **Mobile Ultrafast Gas Chromatography Laboratory**
 - **Fully operable from vehicle power**
 - This Jeep is fitted with a 320 Amp alternator
 - The inverter can handle up to 3.5 KW
 - All equipment is normal 110 to 240 AC driven
 - **Can also be run from shore power (AC either 119 or 240 VAC)**
 - **Portable generator power is also possible**
 - **This Jeep is a sales/marketing tool for the transportable platform and will be on display at trade shows**
- **Operability**
 - **Everything necessary is included**
 - **Even a “lab” workspace to the left and a printer for reports**



Like This!



