



Use and Disclosure of Data
Information contained herein is classified as EAR99 under the
U.S. Export Administration Regulations.
Export, reexport or diversion contrary to U.S. law is prohibited.

OPERATING INSTRUCTIONS FOR

Model 3000MB

Percent Oxygen Analyzer



 **DANGER** 

HIGHLY TOXIC AND OR FLAMMABLE LIQUIDS OR GASES MAY BE PRESENT IN THIS MONITORING SYSTEM.

PERSONAL PROTECTIVE EQUIPMENT MAY BE REQUIRED WHEN SERVICING THIS SYSTEM.

HAZARDOUS VOLTAGES EXIST ON CERTAIN COMPONENTS INTERNALLY WHICH MAY PERSIST FOR A TIME EVEN AFTER THE POWER IS TURNED OFF AND DISCONNECTED.

ONLY AUTHORIZED PERSONNEL SHOULD CONDUCT MAINTENANCE AND/OR SERVICING. BEFORE CONDUCTING ANY MAINTENANCE OR SERVICING CONSULT WITH AUTHORIZED SUPERVISOR/MANAGER.

M3000MB
04/29/2015

Copyright © 2015 Teledyne Analytical Instruments

All Rights Reserved. No part of this manual may be reproduced, transmitted, transcribed, stored in a retrieval system, or translated into any other language or computer language in whole or in part, in any form or by any means, whether it be electronic, mechanical, magnetic, optical, manual, or otherwise, without the prior written consent of Teledyne Analytical Instruments, 16830 Chestnut Street, City of Industry, CA 91748.

Warranty

This equipment is sold subject to the mutual agreement that it is warranted by us free from defects of material and of construction, and that our liability shall be limited to replacing or repairing at our factory (without charge, except for transportation), or at customer plant at our option, any material or construction in which defects become apparent within one year from the date of shipment, except in cases where quotations or acknowledgments provide for a shorter period. Components manufactured by others bear the warranty of their manufacturer. This warranty does not cover defects caused by wear, accident, misuse, neglect or repairs other than those performed by Teledyne or an authorized service center. We assume no liability for direct or indirect damages of any kind and the purchaser by the acceptance of the equipment will assume all liability for any damage which may result from its use or misuse.

We reserve the right to employ any suitable material in the manufacture of our apparatus, and to make any alterations in the dimensions, shape or weight of any parts, in so far as such alterations do not adversely affect our warranty.

Important Notice

This instrument provides measurement readings to its user, and serves as a tool by which valuable data can be gathered. The information provided by the instrument may assist the user in eliminating potential hazards caused by his process; however, it is essential that all personnel involved in the use of the instrument or its interface, with the process being measured, be properly trained in the process itself, as well as all instrumentation related to it.

The safety of personnel is ultimately the responsibility of those who control process conditions. While this instrument may be able to provide early warning of imminent danger, it has no control over process conditions, and it can be misused. In particular, any alarm or control systems installed must be tested and understood, both as to how they operate and as to how they can be defeated. Any safeguards required such as locks, labels, or redundancy, must be provided by the user or specifically requested of Teledyne at the time the order is placed.

Therefore, the purchaser must be aware of the hazardous process conditions. The purchaser is responsible for the training of personnel, for providing hazard warning methods and instrumentation per the appropriate standards, and for ensuring that hazard warning devices and instrumentation are maintained and operated properly.

Teledyne Analytical Instruments, the manufacturer of this instrument, cannot accept responsibility for conditions beyond its knowledge and control. No statement expressed or implied by this document or any information disseminated by the manufacturer or its agents, is to be construed as a warranty of adequate safety control under the user's process conditions.

Specific Model Information

The instrument for which this manual was supplied may incorporate one or more options not included with the standard instrument. Commonly available options are listed below, with check boxes. Any that are incorporated in the instrument for which this manual is supplied are indicated by a check mark in the box.

Instrument Serial Number _____

includes the following options:

- 3000MB-C:** In addition to all standard features, this model also has separate ports for zero and span gases, and built-in control valves. The internal valves are entirely under the control of the 3000MB electronics, to automatically switch between gases in synchronization with the analyzer's operations

- 3000MB-M:** In models with this option, the 4-20 mA Analog Current output is active. (In the standard units, it is not active.)

Table of Contents

1 Introduction

1.1 Overview	1-1
1.2 Typical Applications	1-1
1.3 Main Features of the Analyzer	1-1
1.4 Model Designations	1-2
1.5 Front Panel (Operator Interface)	1-3
1.6 Interface Panel	1-5

2 Operational Theory

2.1 Introduction	2-1
2.2 Precise Paramagnetic Sensor	2-1
2.2.1 Principles of Operation	2-1
2.3 Cross Interface	2-3
2.4 Sample System	2-5
2.5 Electronics and Signal Processing	2-6

3 Installation

3.1 Unpacking the Analyzer	3-1
3.2 Mounting the Analyzer	3-1
3.3 Rear Panel Connections	3-2
3.3.1 Primary Input Power	3-4
3.3.2 Fuse Installation	3-4
3.3.3 Analog Outputs	3-4
3.3.4 Alarm Relays	3-6
3.3.5 Digital Remote Cal Input	3-7
3.3.6 Range ID Relays	3-9
3.3.7 Network I/O	3-9
3.3.8 R/S-232 Port	3-9
3.3.9 Remote Sensor and Solenoid Valves	3-10
3.4 Gas Connection	3-12
3.5 Test The System	3-14

4 Operation

4.1 Introduction	4-1
4.2 Using the Data Entry and Function Buttons	4-2
4.3 The <i>System</i> Function	4-3
4.3.1 Setting the Display	4-4
4.3.2 Setting up an Auto-Cal	4-5
4.3.3 Password Protection	4-5

4.3.3.1	Entering the Password	4-6
4.3.3.2	Installing or Changing the Password	4-7
4.3.4	Logout	4-8
4.3.5	System Self-Diagnostic Test	4-9
4.3.6	Version Screen	4-9
4.4	The <i>Span</i> Functions	4-10
4.4.1	Span Cal	4-10
4.4.1.1	Auto Mode Spanning	4-10
4.4.1.2	Manual Mode Spanning	4-11
4.5	The <i>Alarms</i> Function	4-12
4.6	The <i>Range</i> Function	4-14
4.6.1	Setting the Analog Output Ranges	4-15
4.6.2	Autoranging Analysis	4-15
4.6.3	Fixed Range Analysis	4-15
4.7	The <i>Analyze</i> Function	4-16
4.8	Signal Output	4-16

Maintenance

5.1	Fuse Replacement	5-1
5.2	System Self Diagnostic Test	5-2
5.3	Major Internal Components	5-2
5.4	Cleaning	5-3
5.5	Troubleshooting	5-3

Appendix

A-1	Model 3000MB Specifications	A-1
A-2	Recommended 2-Year Spare Parts List	A-2
A-3	Drawing List	A-3
A-4	Zero Cal	A-4



This is a general purpose instrument designed for usage in a nonhazardous area. It is the customer's responsibility to ensure safety especially when combustible gases are being analyzed since the potential of gas leaks always exist.

The customer should ensure that the principles of operating of this equipment is well understood by the user. Misuse of this product in any manner, tampering with its components, or unauthorized substitution of any component may adversely affect the safety of this instrument.

Since the use of this instrument is beyond the control of Teledyne, no responsibility by Teledyne, its affiliates, and agents for damage or injury from misuse or neglect of this equipment is implied or assumed.

Introduction

1.1 Overview

The Teledyne Analytical Instruments Model 3000MB Percent Oxygen Analyzer is a versatile microprocessor-based instrument for detecting the percentage of oxygen in a variety of background gases. This manual covers the Model 3000MB General Purpose flush-panel and/or rack-mount units only. These units are for indoor use in a nonhazardous environment.

1.2 Typical Applications

A few typical applications of the Model 3000MB are:

- Monitoring inert gas blanketing
- Air separation and liquefaction
- Chemical reaction monitoring
- Semiconductor manufacturing
- Petrochemical process control
- Quality assurance
- Gas analysis certification.

1.3 Main Features of the Analyzer

The Model 3000MB Percent Oxygen Analyzer is sophisticated yet simple to use. The main features of the analyzer include:

- A 2-line alphanumeric display screen, driven by microprocessor electronics, that continuously prompts and informs the operator.
- High resolution, accurate readings of oxygen content from low percent levels through 100 %. Large, bright, meter readout.

- Advanced Paramagnetic sensor, designed for percent oxygen analysis. Several options are available.
- Versatile analysis over a wide range of applications.
- Microprocessor based electronics: 8-bit CMOS microprocessor with 32 kB RAM and 128 kB ROM.
- Three user definable output ranges (from 0-1% through 0-100 %) allow best match to users process and equipment.
- Air-calibration range for convenient spanning at 20.9 %.
- Auto Ranging allows analyzer to automatically select the proper preset range for a given measurement. Manual override allows the user to lock onto a specific range of interest.
- Two adjustable concentration alarms and a system failure alarm.
- Extensive self-diagnostic testing, at startup and on demand, with continuous power-supply monitoring.
- Two way RFI protection.
- RS-232 serial digital port for use with a computer or other digital communication device.
- Analog outputs for percent-of-range and for range identification. 0–1 V dc. (Isolated 4–20 mA dc optional)
- Convenient and versatile, steel, flush-panel or rack-mountable case with slide-out electronics drawer.

1.4 Model Designations

3000MB: Standard model.

3000MB-C: In addition to all standard features, this model also has separate ports for zero and span gases, and built-in control valves. The internal valves are entirely under the control of the 3000MA electronics, to automatically switch between gases in synchronization with the analyzer's operations.

3000MB-M: This model has current output signals (4-20 mA) for percent-of-range and range ID, in addition to voltage outputs.

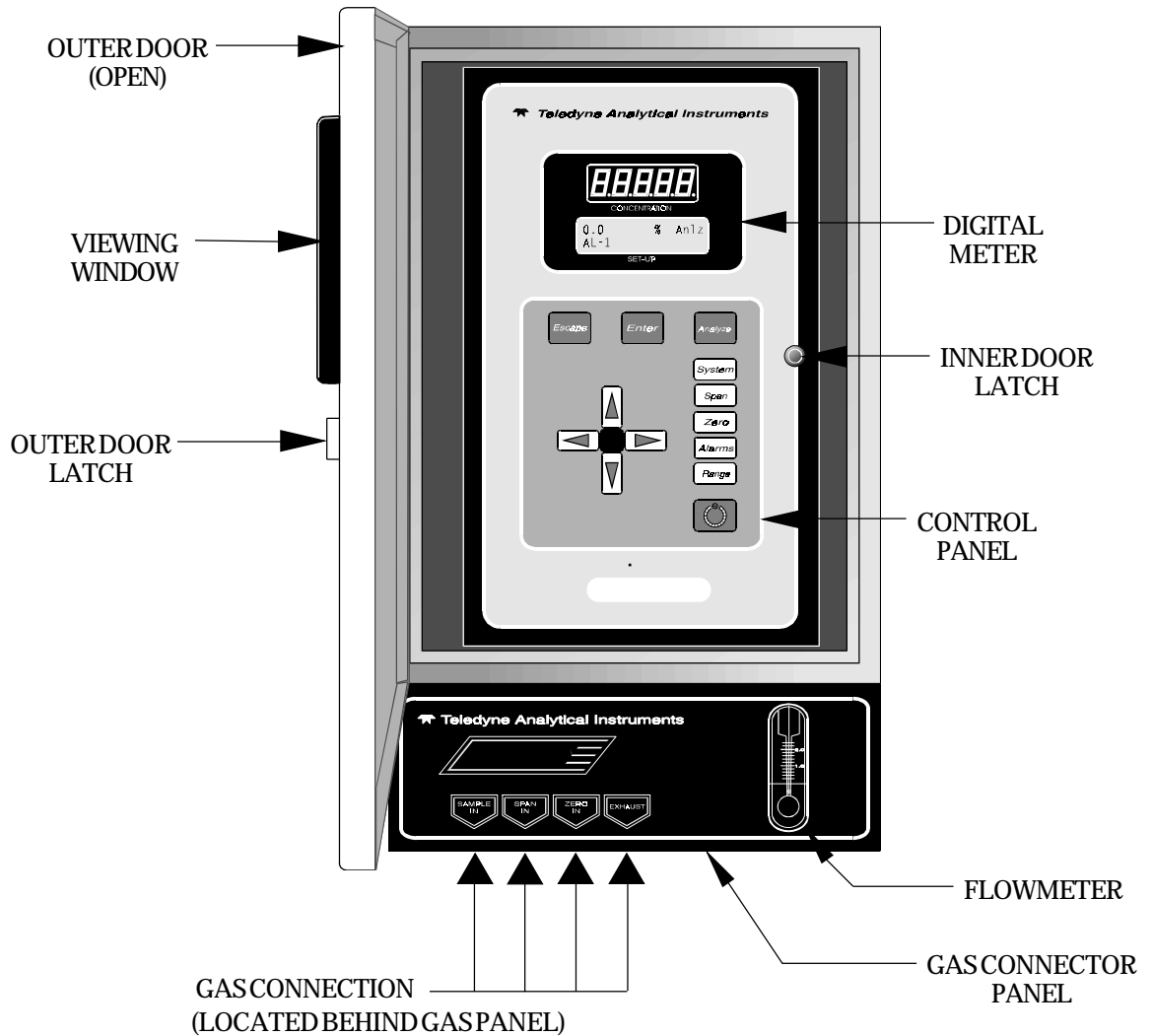

Figure 1-1: Model 3000MB Front Panel

1.5 Front Panel (Operator Interface)

The standard 3000MB is housed in a rugged metal case with all controls and displays accessible from the front panel. See Figure 1-1. The front panel has thirteen buttons for operating the analyzer, a digital meter, an alphanumeric display, and a window for viewing the sample flowmeter.

Function Keys: Six touch-sensitive membrane switches are used to change the specific function performed by the analyzer:

- **Analyze** Perform analysis for oxygen content of a sample gas.
- **System** Perform system-related tasks (described in detail in chapter 4, *Operation*).
- **Span** Span calibrate the analyzer.
- **Zero** Zero calibrate the analyzer.
- **Alarms** Set the alarm setpoints and attributes.
- **Range** Set up the 3 user definable ranges for the instrument.

Data Entry Keys: Six touch-sensitive membrane switches are used to input data to the instrument via the alphanumeric VFD display:

- **Left & Right Arrows** Select between functions currently displayed on the VFD screen.
- **Up & Down Arrows** Increment or decrement values of functions currently displayed.
- **Enter** Moves VFD display on to the next screen in a series. If none remains, returns to the *Analyze* screen.
- **Escape** Moves VFD display back to the previous screen in a series. If none remains, returns to the *Analyze* screen.

Digital Meter Display: The meter display is a LED device that produces large, bright, 7-segment numbers that are legible in any lighting environment. It produces a continuous readout from 0-100 %. It is accurate across all ranges without the discontinuity of analog range switching.

Alphanumeric Interface Screen: The VFD screen is an easy-to-use interface from operator to analyzer. It displays values, options, and messages that give the operator immediate feedback.

Flowmeter: Monitors the flow of gas past the sensor. Readout is 0 to 1000 standard cubic centimeters per minute (SCCM).

Standby Button: The  *Standby* turns off the display and outputs, but circuitry is still operating.

CAUTION: *The power cable must be unplugged to fully disconnect power from the instrument. When chassis is exposed or when access door is open and power cable is connected, use extra care to avoid contact with live electrical circuits.*



Access Door: To provide access to the sensor, the front panel swings open when the latch in the upper right corner of the panel is pressed all the way in with a narrow gauge tool. Accessing the main circuit board requires unfastening the rear panel screws and sliding the unit out of the case.

1.6 Interface Panel (Equipment Interface)

The rear panel, shown in Figure 1-2, contains the gas and electrical connectors for external inlets and outlets. The Zero and Span gas connectors, and the Current signal outputs are optional and may not appear on your instrument. The connectors are described briefly here and in detail in the *Installation* chapter of this manual.

Figure 1-2: Model 3000MB Rear Panel

- **Power Connection** Universal AC power source.
- **Analog Outputs** 0-1 V dc concentration output, plus 0-1 V dc range ID.
- **Alarm Connections** 2 concentration alarms and 1 system alarm.
- **RS-232 Port** Serial digital concentration signal output and control input.
- **Remote Probe** Used in the 3000MB for controlling external solenoid valves only.
- **Remote Span/Zero** Digital inputs allow external control of analyzer calibration.
- **Calibration Contact** To notify external equipment that instrument is being calibrated and readings are not monitoring sample.
- **Range ID Contacts** Four separate, dedicated, range relay contacts. Low, Medium, High, Cal.
- **Network** For future expansion. Not implemented at this printing.

Operational Theory

2.1 Introduction

The analyzer is composed of three subsystems:

1. Paramagnetic Sensor
2. Sample System
3. Electronic Signal Processing, Display and Control

The sample system is designed to accept the sample gas and transport it through the analyzer without contaminating or altering the sample prior to analysis. The Paramagnetic Sensor is an electromechanical device that translates the amount of oxygen present in the sample into an electrical signal. The electronic signal processing, display and control subsystem simplifies operation of the analyzer and accurately processes the sampled data. The microprocessor controls all signal processing, input/output and display functions for the analyzer.

2.2 Precise Paramagnetic Sensor

2.2.1 Principles of Operation

The heart of the 3000MB is a paramagnetic type oxygen sensor that is maintenance free and has a long lifetime. Oxygen has a very high magnetic susceptibility compared to other gases and thus displays a particularly paramagnetic behavior. A small glass dumbbell filled with nitrogen and rotating on a taut platinum wire is suspended in an inhomogeneous magnetic field. This glass dumbbell is diamagnetic and tends to rotate out of the magnetic field. The strength of the resulting torque determined by the susceptibility of the sample gas. This torque is compensated for by a counter torque induced by an electrically charged platinum coil on the dumbbell. The zero position of the dumbbell is controlled by means of an optical system consisting of a light source, a mirror at the dumbbell axis and a pair of detectors. The difference between the compensating currents required to bring the dumb-

bell to the zero position in the presence of zero gas (i.e. no O₂ present) or of sample gas is proportional to the partial pressure of oxygen in the sample gas.

The sensor enclosure is temperature controlled to 55 degrees centigrade to insure that the magnetic susceptibility of oxygen in the sample is not affected by the ambient temperature. The measuring cell has a measuring volume of approximately 3 cm³



Sensor
(side view shown)

The Paramagnetic sensor enclosure holds not only the sensing elements, but the temperature controller electronics, heating elements, sensor electronics, and preamplifier. The Electronics and heating elements require a separate power source, from the rest of the 3000MB capable of delivering 1.5 amps approximately at 24 volts dc. The output of the sensor is roughly calibrated to be 0 to 1 volt DC for the the range of 0 to 100 % O₂. The true calibration of the sensor is carried out by the microprocessor as described later in chapter 4. The electrical interconnections to the sensor are done through a 15 pin D connector. Some signals from the sensor are not connected. They are only useful for troubleshooting, by trained personnel, as test points.

Sensor
(rear view shown)

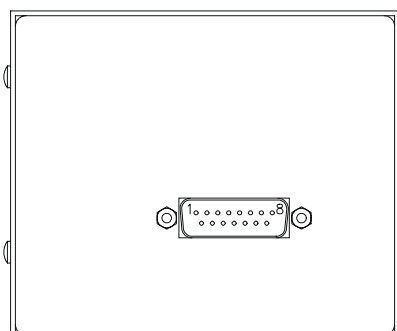

Pin out:

1	-15Vdc test pin (Not connected)
2	+15Vdc test pin (Not connected)
3	Measuring ground
4	Not used
5	Preamplifier output ~0- 1 Vdc
6	Not used
7	24 Vdc return, power ground
8	Collector of transistor switching heating element (Not connected)
9	Fault signal: <0 Vdc= OK, >4.6 Vdc = Fault (Not connected)
10	Not used
11	Negative reference voltage (Not connected)
12	Positive reference voltage (Not connected)
13	Nominal temperature voltage signal (Not connected)
14	Actual temperature voltage signal (Not connected)
15	+24 Vdc power.

2.3 Cross Interference

As mentioned previously, the selectivity of the measuring system is based on the extraordinarily high magnetic susceptibility of Oxygen compared to other gases. In most cases the presence of other gases can be ignored but significant errors can occur when the sensor is calibrated with a mixture of oxygen and nitrogen and the sample gas consists mainly of other gases with considerable magnetic susceptibility. In this case, the reading shows a measured value even if the sample gas contains no Oxygen. It is actually displaying the cross sensitivity to another gas.

The following table shows the cross sensitivity of some gases when changing from pure nitrogen to 100% of one of the gases listed.

Gas	Cross Sensitivity in vol. %	Gas	Cross Sensitivity in vol. %
Acetylene C ₂ H ₂	-0.24	Hydrogen chloride HCl	-0.30
Allene C ₃ H ₄	-0.44	Hydrogen fluoride HF	+0.10
Ammonia NH ₃	-0.26	Hydrogen iodide HI	-1.10
Argon Ar	-0.22	Hydrogen sulphide H ₂ S	-0.39
Bromine Br ₂	-1.30	Iodine I	-2.40
1.2 Butadiene C ₄ H ₆	-0.49	Isobutane C ₄ H ₁₀	-1.11
1.3 Butadiene C ₄ H ₆	-0.49	Isopentane C ₅ H ₁₂	-1.49
n-Butane C ₄ H ₁₀	-1.11	Krypton Kr	-0.51
I-Butane C ₄ H ₈	-0.85	Laughing gas N ₂ O	-0.20
cis 2-Butane C ₄ H ₈	-0.89	Methane CH ₄	-0.20
trans 2-Butane C ₄ H ₈	-0.92	Neon Ne	+0.13
Carbon dioxide CO ₂	-0.27	Neopentane C ₅ H ₁₂	-1.49
Carbon monoxide CO	+0.06	Nitric acid HNO ₃	+0.43
Chlorine Cl ₂	-0.77	Nitrogen dioxide NO ₂	+28.00
Cyclo hexane C ₆ H ₁₂	-1.56	Nitrous oxide NO	+40.00
Ethane C ₂ H ₆	-0.43	n-Octane C ₈ H ₁₈	-2.50
Ethylene C ₂ H ₄	-0.26	n-Pentane C ₅ H ₁₂	-1.45
Helium He	+0.30	Propane C ₃ H ₈	-0.86
n-Heptane C ₇ H ₁₆	-2.10	Propylene C ₃ H ₆	-0.55
n-Hexane C ₆ H ₁₄	-1.70	Vinyl chloride	-0.63
Hydrogen H ₂	+0.24	Water H ₂ O	-0.02
Hydrogen bromide HBr	-0.61	Xenon Xe	-0.95

With gas mixtures the components are weighted according to their proportional volumes.

The cross interference with a gas mixture can be determined in advance if the concentration of the individual background gases is known.

Example:

Cross sensitivity calculation for a gas mixture:

The gas to be measured consists of 10 % CO₂, 40 % of N₂, and 50% of Ar.

$$\text{CO}_2: -0.27 \times 10\% = -0.027$$

$$\text{Ar: } -0.22 \times 50\% = -0.11$$

$$\text{TOTAL CROSS INTERFERENCE } -0.137$$

Calculation of the zero value:

$$(0\% \text{ O}_2) - (\text{Cross Interference Value}) = \text{Zero Point Value}$$

$$0\% - (-0.137) = +0.137\% \text{ O}_2$$

2.4 Sample System

The sample system delivers gases to the sensor from the analyzer gas panel inlets. Depending on the mode of operation either sample or calibration gas is delivered.

The Model 3000MB sample system is designed and fabricated to ensure that the oxygen concentration of the gas is not altered as it travels through the sample system. The sample encounters almost no dead space. This minimizes residual gas pockets that can interfere with low percent range analysis.

The sample system for the standard instrument incorporates ¼ inch tube fittings for sample inlet and outlet connections at the rear panel. For metric system installations, 6 mm adapters are available with each instrument to be used if needed. The sample or calibration gas flowing through the system is monitored by a flowmeter downstream from the sensor.

The gases delivered to the instrument should be at constant pressures and flow rates and must exit freely into the ambient atmosphere. The Span, Zero and Sample gases should be delivered at constant pressures of about 10 psig (Range 5-20). The flow rate must be maintained at about 700 cc/minute (Range 500-900) and must exit freely into atmospheric pressure.

Figure 2-4 is the flow diagram for the sampling system. In the standard instrument, calibration gases (zero and span) can be connected directly to the Sample In port by teeing to the port with appropriate valves. The shaded portions of the diagram show the components added when the -C options are ordered. The solenoid valves, when supplied, are installed inside the 3000MB enclosure and are regulated by the instruments internal electronics.

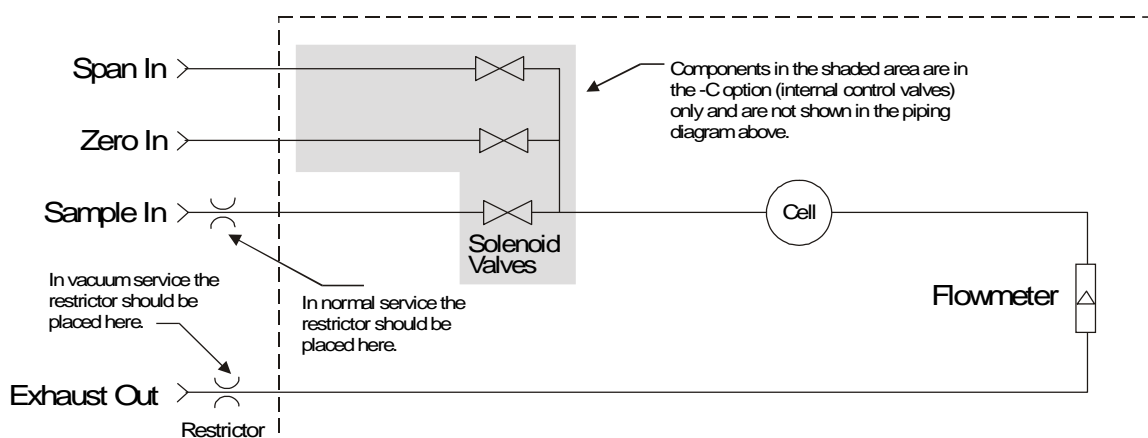

Figure 2-4: Flow Diagram

2.5 Electronics and Signal Processing

The Model 3000MB Percent Oxygen Analyzer uses an 8031 microcontroller with 32 kB of RAM and 128 kB of ROM to control all signal processing, input/output, and display functions for the analyzer. System power is supplied from a universal power supply module designed to be compatible with any international power source. Figure 2-6 shows the location of the power supply and the main electronic PC boards.

The signal processing electronics including the microprocessor, analog to digital, and digital to analog converters are located on the motherboard at the bottom of the case. The preamplifier board is mounted on top of the motherboard as shown in the figure. These boards are accessible after removing the back panel. Figure 2-7 is a block diagram of the Analyzer electronics.

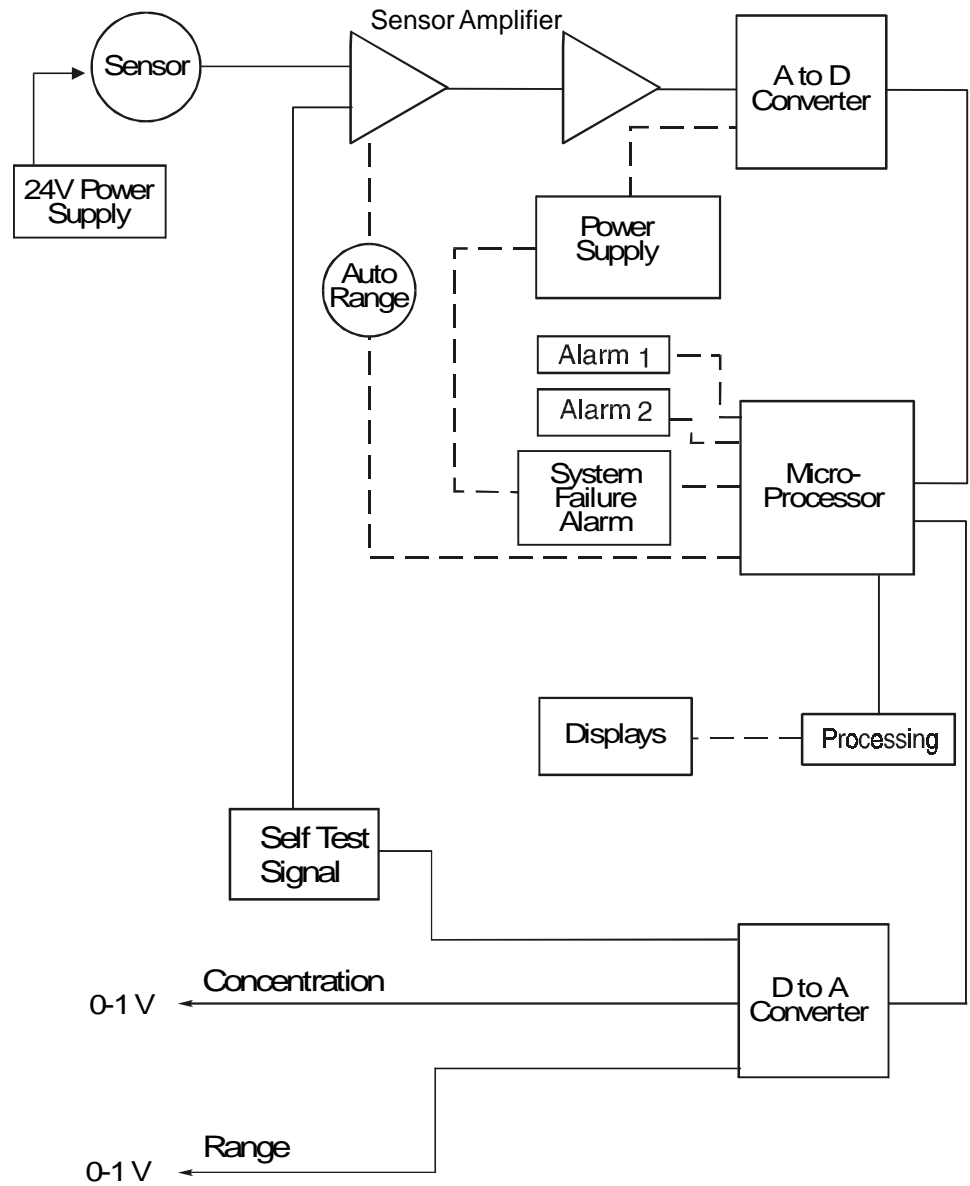

Figure 2-6: Block Diagram of the Model 3000MB Electronics

Installation

Installation of the Model 3000PB Analyzer includes:

1. Unpacking
2. Mounting
3. Gas connections
4. Electrical connections
5. Installing the Micro-Fuel Cell
6. Testing the system.

3.1 Unpacking the Analyzer

The analyzer is shipped with all the materials you need to install and prepare the system for operation. Carefully unpack the analyzer and inspect it for damage. Immediately report any damage to the shipping agent.

3.2 Mounting the Analyzer

The Model 3000PB is designed for bulkhead mounting in nonhazardous environments. There are four mounting lugs—one in each corner of the enclosure. The outline drawing, at the back of this manual, gives the mounting hole size and spacing. The drawing also contains the overall dimensions. Do not forget to allow an extra 1³/₈" for the hinges.

Be sure to allow enough space in front of the enclosure to swing the outer door open—a 11 ³/₄" radius, as shown in Figure 3-2.

All electrical connections are made via cables which enter the NEMA-4 housing through ports in its side. No conduit fittings are supplied. The installer must provide two 3/4" NPT and two 1" NPT adapters and the appropriate sealing conduit.

For gas connections, the unit is supplied with 1/4" tube fittings, and 6 millimeter adapters are supplied for metric system installations.

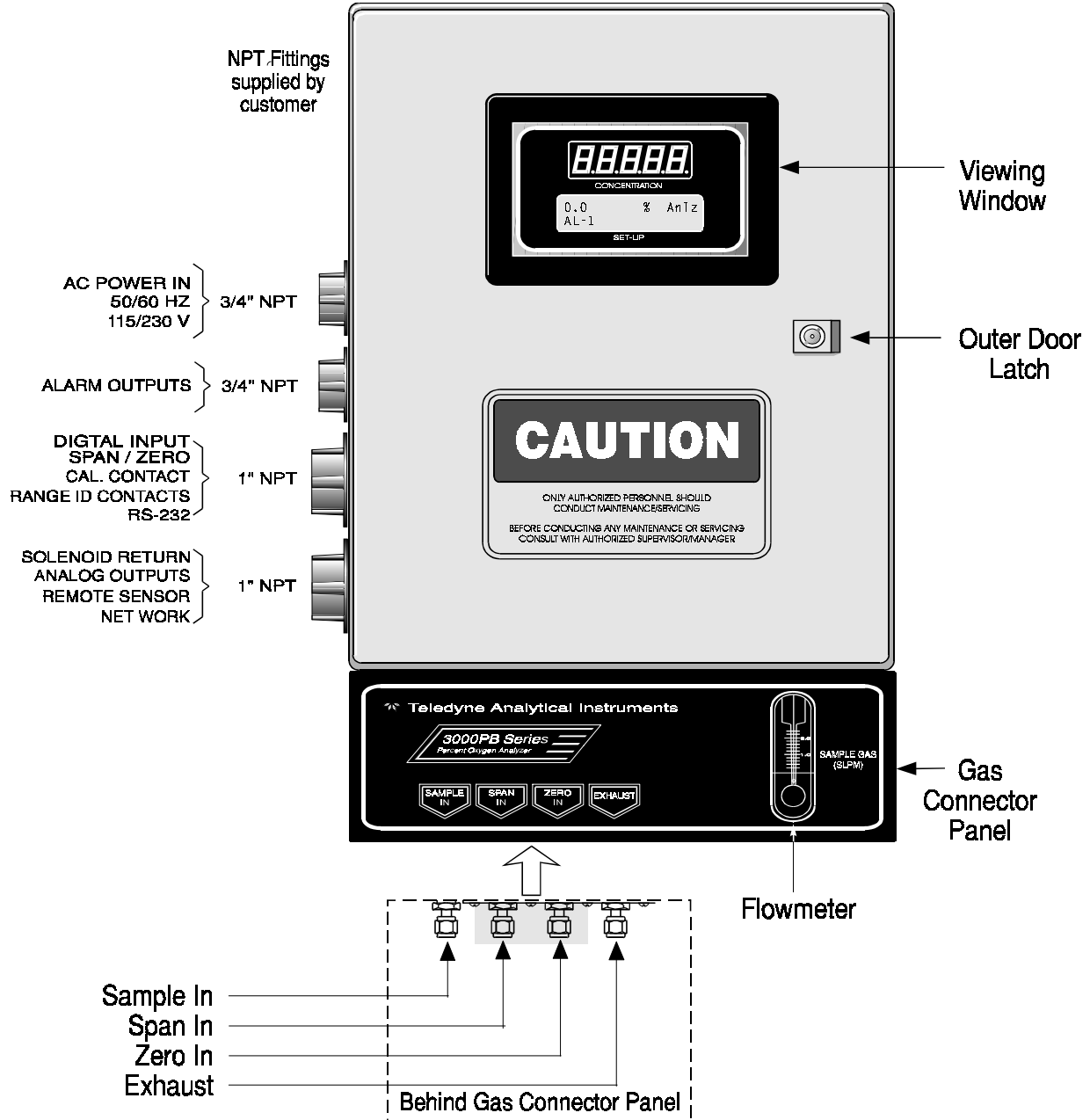

Figure 3-1: Front View of the Model 3000MB (Simplified)

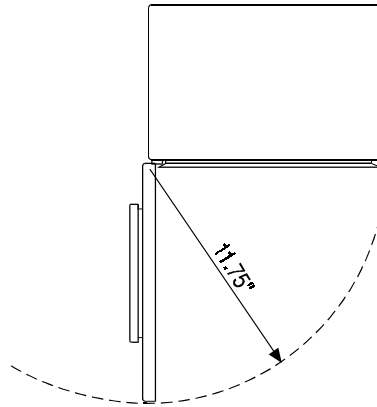
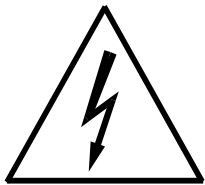

Figure 3-2: Required Front Door Clearance



3.3 Electrical Connections

Figure 3-3 shows the Model 3000MB Electrical Connector Panel. There are terminal blocks for connecting power, communications, and both digital and analog concentration outputs.

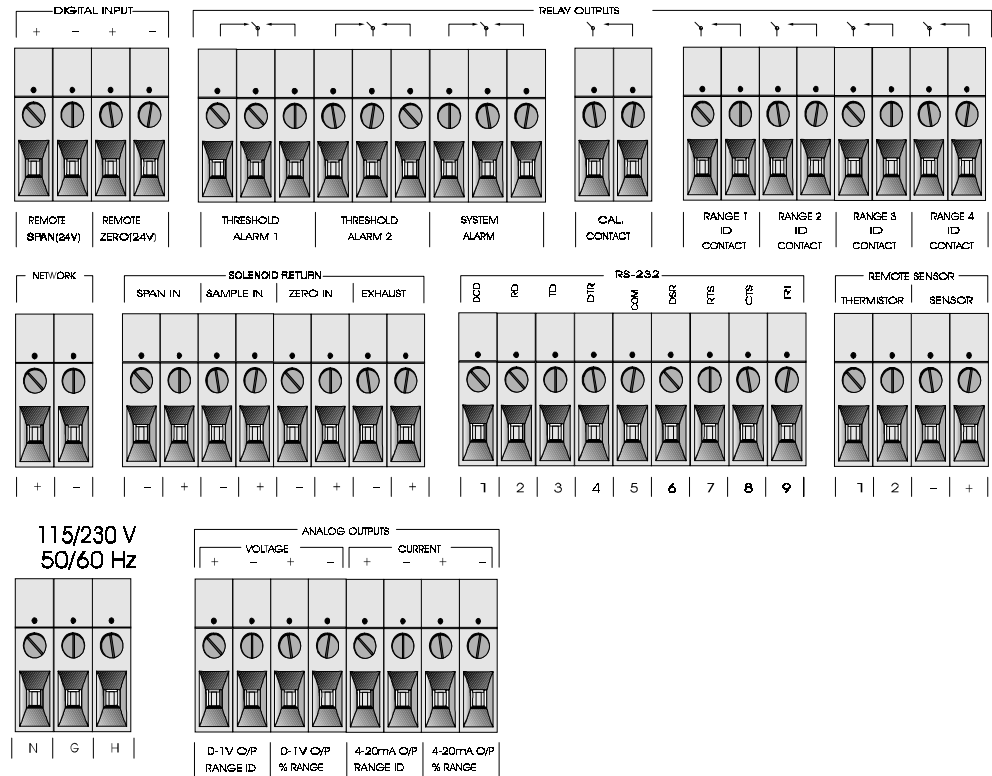

Figure 3-3: Electrical Connector Panel

For safe connections, ensure that no uninsulated wire extends outside of the connectors they are attached to. Stripped wire ends must insert completely into terminal blocks. No uninsulated wiring should be able to come in contact with fingers, tools or clothing during normal operation. Terminal block can accept wire gauge 20 to 10.

3.3.1 Primary Input Power

The universal power supply requires a 115 or 230 V ac, 50 or 60 Hz, power source. The actual input voltage used must show in the window of the VOLTAGE SELECTOR switch **before** the power source is connected. See Figure 3-4 for detailed connections.

DANGER: *Power is applied to the instrument's circuitry as long as the instrument is connected to the power source. The Standby function switches power on or off to the displays and outputs only.*

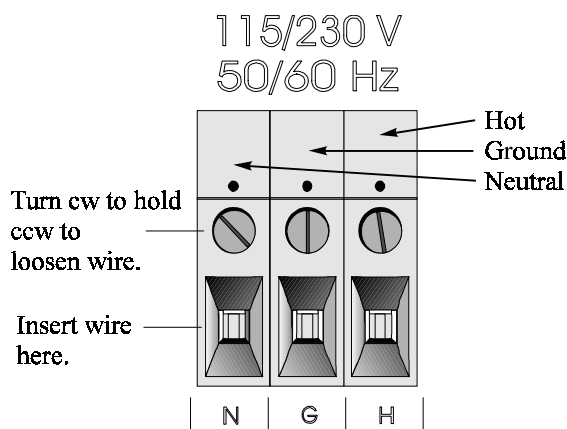

Figure 3-4: Primary Input Power Connections

3.3.2 Fuse Installation

The fuse holders accept 5 x 20 mm, 4.0 A, T type (slow blow) fuses. Fuses are not installed at the factory. Be sure to install the proper fuse as part of installation. (See *Fuse Replacement* in chapter 5, *maintenance*.)

3.3.3 Analog Outputs

There are eight DC output signal connectors on the ANALOG OUTPUTS connector block. There are two connectors per output with the polarity noted. See Figure 3-5.

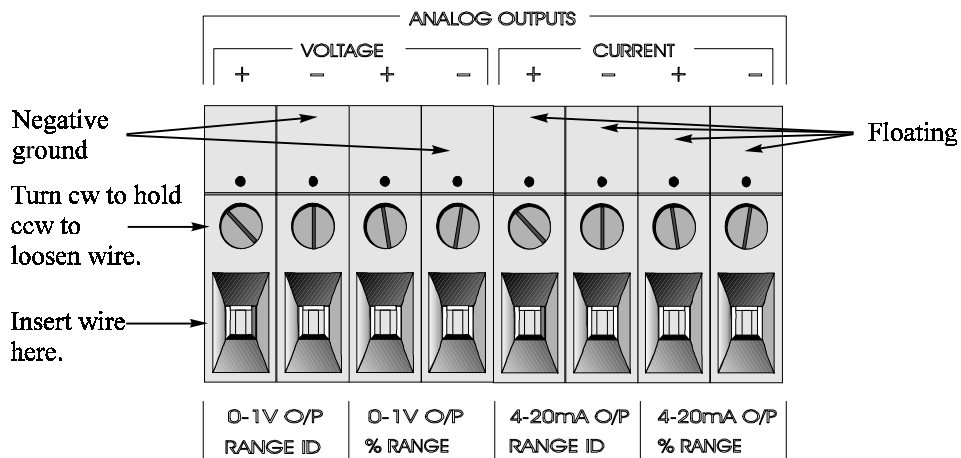

Figure 3-5: Analog Output Connections

The outputs are:

0–1 V dc % of Range: Voltage rises linearly with increasing oxygen, from 0 V at 0 % to 1 V at 100 %. (Full scale = 100% of programmable range.)

0–1 V dc Range ID: 0.25 V = Low Range, 0.5 V = Medium Range, 0.75 V = High Range, 1 V = Air Cal Range.

4–20 mA dc % Range: (-M Option) Current increases linearly with increasing oxygen, from 4 mA at 0 % to 20 mA at full scale 100 %. (Full scale = 100% of programmable range.)

4–20 mA dc Range ID: (-M Option) 8 mA = Low Range, 12 mA = Medium Range, 16 mA = High Range, 20 mA = Air Cal Range.

Examples:

The analog output signal has a voltage which depends on the oxygen concentration AND the currently activated analysis range. To relate the signal output to the actual concentration, it is necessary to know what range the instrument is currently on, especially when the analyzer is in the autoranging mode.

The signal output for concentration is linear over the currently selected analysis range. For example, if the analyzer is set on a range that was defined as 0–10 % O₂, then the output would be as shown in Table 3-1.

Table 3-1: Analog Concentration Output—Example

% O₂	Voltage Signal Output (V dc)	Current Signal Output (mA dc)
0	0.0	4.0
1	0.1	5.6
2	0.2	7.2
3	0.3	8.8
4	0.4	10.4
5	0.5	12.0
6	0.6	13.6
7	0.7	15.2
8	0.8	16.8
9	0.9	18.4
10	1.0	20.0

To provide an indication of the range, a second pair of analog output terminals are used. They generate a steady preset voltage (or current when using the current outputs) to represent a particular range. Table 3-2 gives the range ID output for each analysis range.

Table 3-2: Analog Range ID Output—Example

Range	Voltage (V)	Current (mA)
LO	0.25	8
MED	0.50	12
HI	0.75	16
CAL (0-25%)	1.00	20

3.3.4 Alarm Relays

There are three alarm-circuit connectors on the alarm relays block (under RELAY OUTPUTS) for making connections to internal alarm relay contacts. Each provides a set of Form C contacts for each type of alarm. Each has both normally open and normally closed contact connections. The contact connections are indicated by diagrams on the rear panel. They are capable of switching up to 3 amperes at 250 V ac into a resistive load. See Figure 3-6.

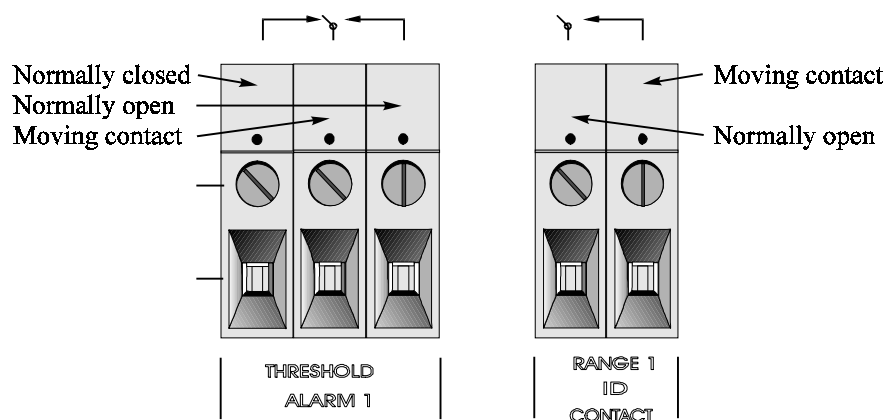

Figure 3-6: Types of Relay Contacts

The connectors are:

- Threshold Alarm 1:**
- Can be configured as high (actuates when concentration is above threshold), or low (actuates when concentration is below threshold).
 - Can be configured as failsafe or nonfailsafe.
 - Can be configured as latching or nonlatching.
 - Can be configured out (defeated).
- Threshold Alarm 2:**
- Can be configured as high (actuates when concentration is above threshold), or low (actuates when concentration is below threshold).
 - Can be configured as failsafe or nonfailsafe.
 - Can be configured as latching or nonlatching.
 - Can be configured out (defeated).
- System Alarm:** Actuates when DC power supplied to circuits is unacceptable in one or more parameters. Permanently configured as failsafe and latching. Cannot be defeated. Actuates if self test fails.
- To reset a System Alarm during installation, disconnect power to the instrument and then reconnect it.

Further detail can be found in chapter 4, section 4-5.

3.3.5 Digital Remote Cal Inputs

Remote Zero and Span Inputs: The REMOTE SPAN and REMOTE ZERO inputs are on the DIGITAL INPUT terminal block. They accept 0 V (OFF) or 24 V dc (ON) for remote control of calibration. (See *Remote Calibration Protocol* below.)

- ZERO:** Floating input. 5 to 24 V input across the + and – terminals puts the analyzer into the *Zero* mode. Either side may be grounded at the source of the signal. 0 to 1 volt across the terminals allows *Zero* mode to terminate when done. A synchronous signal must open and close the external zero valve appropriately. See 3.3.9 *Remote Sensor and Solenoid Valves*. (With the –C option, the internal valves automatically operate synchronously.)
- SPAN:** Floating input. 5 to 24 V input across the + and – terminals puts the analyzer into the *Span* mode. Either side may be grounded at the source of the signal. 0 to 1 volt across the terminals allows *Span* mode to terminate when done. A synchronous signal must open and close the external span valve appropriately. See 3.3.9 *Remote Sensor and Solenoid Valves*. (With the –C option, the internal valves automatically operate synchronously.)

Cal Contact: This relay contact is closed while analyzer is spanning and/or zeroing. (See *Remote Calibration Protocol* below.)

Remote Calibration Protocol: To properly time the Digital Remote Cal Inputs to the Model 3000MB Analyzer, the customer's controller must monitor the CAL CONTACT relay.

When the contact is OPEN, the analyzer is analyzing, the Remote Cal Inputs are being polled, and a zero or span command can be sent.

When the contact is CLOSED, the analyzer is already calibrating. It will ignore your request to calibrate, and it will not remember that request.

Once a zero or span command is sent, and acknowledged (contact closes), release it. If the command is continued until after the zero or span is complete, the calibration will repeat and the Cal Relay Contact (CRC) will close again.

For example:

- 1) Test the CRC. When the CRC is open, Send a zero command until the CRC closes (The CRC will quickly close.)
- 2) When the CRC closes, remove the zero command.
- 3) When CRC opens again, send a span command until the CRC closes. (The CRC will quickly close.)
- 4) When the CRC closes, remove the span command.

When CRC opens again, zero and span are done, and the sample is being analyzed.

Note: The remote probe connections (paragraph 3.3.9) provides signals to ensure that the zero and span gas valves will be controlled synchronously. If you have the –C Internal valve option—which includes additional zero and span gas inputs—the 3000MB automatically regulates the zero, span and sample gas flow.

3.3.6 Range ID Relays

There are four dedicated RANGE ID CONTACT relays. The first three ranges are assigned to relays in ascending order—Low range is assigned to RANGE 1 ID, Medium range is assigned to RANGE 2 ID, and High range is assigned to RANGE 3 ID. RANGE 4 ID is reserved for the Air Cal Range (25%).

3.3.7 Network I/O

A serial digital input/output for local network protocol. At this printing, this port is not yet functional. It is to be used in future versions of the instrument.

3.3.8 RS-232 Port

The digital signal output is a standard RS-232 serial communications port used to connect the analyzer to a computer, terminal, or other digital device. The pinouts are listed in Table 3-3.

Table 3-3: RS-232 Signals

RS-232 Sig	RS-232 Pin	Purpose
DCD	1	Data Carrier Detect
RD	2	Received Data
TD	3	Transmitted Data
DTR	4	Data Terminal Ready
COM	5	Common
DSR	6	Data Set Ready
RTS	7	Request to Send
CTS	8	Clear to Send
RI	9	Ring Indicator

The data sent is status information, in digital form, updated every two seconds. Status is reported in the following order:

- The concentration in percent

- The range in use (HI, MED, LO)
- The span of the range (0-100 %, etc)
- Which alarms—if any—are disabled (AL-x DISABLED)
- Which alarms—if any—are tripped (AL-x ON).

Each status output is followed by a carriage return and line feed.

Three input functions using RS-232 have been implemented to date. They are described in Table 3-4.

Table 3-4: Commands via RS-232 Input

Command	Description
as <enter>	Immediately starts an autospan.
az <enter>	Immediately starts an autozero.
co <enter>	Reports “Raw Cell Output” (current output of the sensor itself) in μA . For example— Raw Cell Output: 99 μA
st <enter>	Toggling input. Stops/Starts any status message output from the RS-232, until st <enter> is sent again.

The RS-232 protocol allows some flexibility in its implementation. Table 3-5 lists certain RS-232 values that are required by the 3000MB implementation.

Table 3-5: Required RS-232 Options

Parameter	Setting
Baud	2400
Byte	8 bits
Parity	none
Stop Bits	1
Message Interval	2 seconds

3.3.9 Remote Sensor and Solenoid Valves

The 3000PB is a single-chassis instrument, which has its own sensor and, in the -C option, its own gas-control solenoid valves. However, The REMOTE SENSOR and SOLENOID RETURN connectors are provided for use with a remote sensor and/or sampling system, if desired. See Figures 3-7 and 3-8.

11-1	Thermistor Return	Remote Thermistor
11-2	Thermistor Hot	Remote Thermistor
11-3	Sensor Return (-)	Remote Sensor -
11-4	Sensor Hot (+)	Remote Sensor +

Figure 3-7: Remote Sensor Connector Pinouts

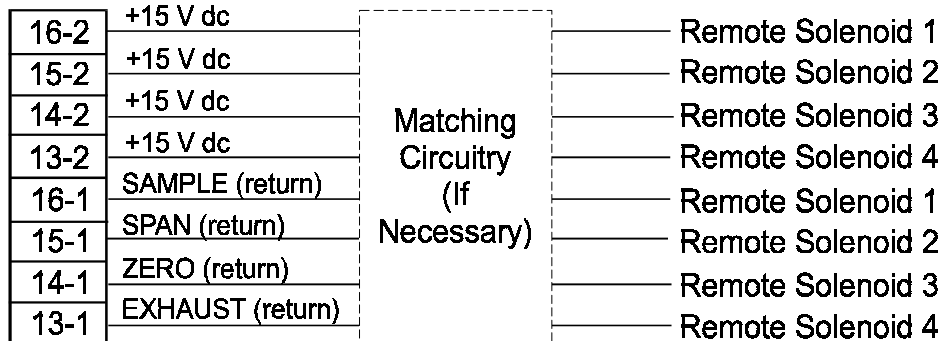

Figure 3-8: Remote Solenoid Return Connector Pinouts

The voltage from these outputs is nominally 0 V for the OFF and 15 V dc for the ON conditions. The maximum combined current that can be pulled from these output lines is 100 mA. (If two lines are ON at the same time, each must be limited to 50 mA, etc.) If more current and/or a different voltage is required, use a relay, power amplifier, or other matching circuitry to provide the actual driving current.

In addition, each individual line has a series FET with a nominal ON resistance of 5 ohms (9 ohms worst case). This could limit the obtainable voltage, depending on the load impedance applied. See Figure 3-9.

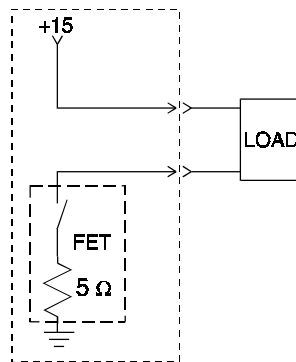

Figure 3-9: FET Series Resistance

3.4 Gas Connections

Before using this instrument, it should be determined if the unit will be used for pressurized service or vacuum service and low pressure applications. Inspect the restrictor kit that came with the unit. The kit consists of two restrictors and a union for 1/4" diameter tubing. Notice that the two 1 3/4" long, 1/4" diameter tubing are restrictors. It has an open end and a closed end with a small circular orifice. The restrictor without the blue sticker is for low pressure and vacuum service. For high pressure (5 to 50 psig) applications, use the restrictor that has a blue sticker on the body.

For pressurized service, use the restrictor without the blue dot and union from the restrictor kit and attach it to the Sample In port. The small circular orifice should face away from the back of the unit (against the direction of gas flow). Use the restrictor without the blue dot sticker in the same manner for low pressure applications (less than 5 psig).

For vacuum service (5-10 in Hg), use the restrictor without the blue dot sticker and union but attach it to the Exhaust Out port. The small circular orifice should face toward the back of the unit (against the direction of gas flow).

Remove the blue sticker from the restrictor before using.

WARNING *Operating the unit without restrictors can cause damage to the micro-fuel cell.*

Figure 3-10 is an illustration of the Gas Connector Panel. Optional gas connections are shown in shaded blocks.

The unit is manufactured with 1/4 inch tube fittings, and 6 mm adapters are supplied for metric system installations.

For a safe connection:

1. Insert the tube into the tube fitting, and finger-tighten the nut until the tubing cannot be rotated freely, by hand, in the fitting. (This may require an additional 1/8 turn beyond finger-tight.)
2. Hold the fitting body steady with a backup wrench, and with another wrench rotate the nut another 1 1/4 turns.

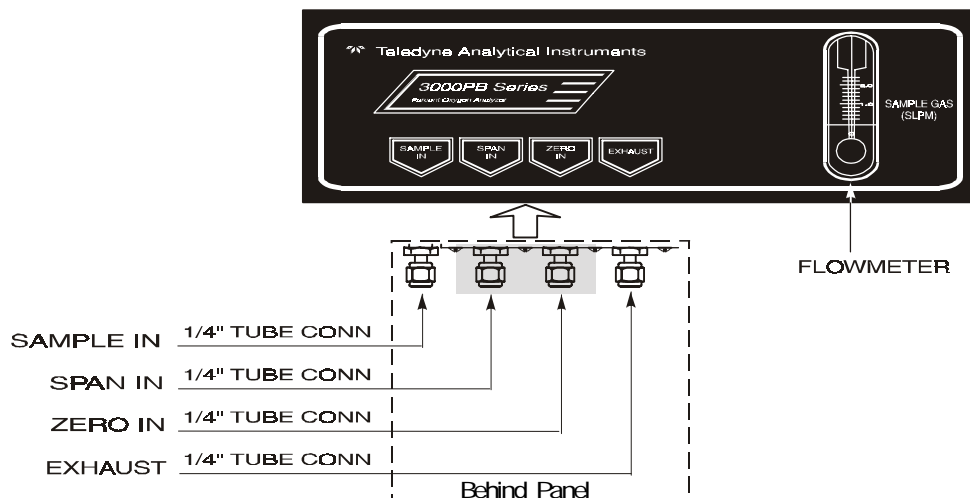

Figure 3-10: Gas Connector Panel

SAMPLE IN: In the standard model, gas connections are made at the SAMPLE IN and EXHAUST OUT connections. Calibration gases must be Tee'd into the Sample inlet with appropriate valves.

The gas pressure in should be reasonably regulated. Pressures between 3 and 40 psig are acceptable as long as the pressure, once established, will keep the front panel flowmeter reading in an acceptable range (0.1 to 2.4 SLPM). Exact figures will depend on your process.

If greater flow is required for improved response time, install a bypass in the sampling system upstream of the analyzer input.

Note: If you have the -V option, The above numbers apply instead to the vacuum at the EXHAUST OUT connector, described below, with minus signs before the pressure readings.

ZERO IN and SPAN IN: These are additional ports, included on models with the -C option, for inputting span gas and zero gas. There are electrically operated valves inside for automatic switching between sample and calibration gases. These valves are completely under control of the 3000PB Electronics. They can be externally controlled only indirectly through the Remote Cal Inputs, described below.

Pressure, flow, and safety considerations are the same as prescribed for the SAMPLE IN inlet, above.

EXHAUST OUT: Exhaust connections must be consistent with the hazard level of the constituent gases. Check Local, State, and Federal laws, and ensure that the exhaust stream vents to an appropriately controlled area if required.

Note: If your 3000MB has the –V option, see *Sample In*, above, for gas pressure/flow considerations.

3.5 Testing the System

Before plugging the instrument into the power source:

- Check the integrity and accuracy of the gas connections. Make sure there are no leaks.
- Check the integrity and accuracy of the electrical connections. Make sure there are no exposed conductors
- Check that sample pressure is between 3 and 40 psig, according to the requirements of your process.
- Check that the voltage selector switch on the Electrical Connector Panel is in the appropriate position for your power source.

Power up the system, and test it by performing the following operations:

1. Repeat the Self-Diagnostic Test as described in chapter 4, section 4.3.5.

Operation

4.1 Introduction

Once the analyzer has been installed, it can be configured for your application. To do this you will:

- Set system parameters:
 - Establish a security password, if desired, requiring Operator to log in.
 - Establish and start an automatic calibration cycle, if desired.
- Calibrate the instrument.
- Define the three user selectable analysis ranges. Then choose autoranging or select a fixed range of analysis, as required.
- Set alarm setpoints, and modes of alarm operation (latching, failsafe, etc).

Before you configure your 3000MB these default values are in effect:

Ranges: LO = 1 %, MED = 5 %, HI = 10 %

Auto Ranging: ON

Alarm Relays: Defeated, 10 %, HI, Not failsafe, Not latching

Zero: Auto, every 0 days at 0 hours

Span: Auto, at 20.9 %, every 0 days at 0 hours

If you choose not to use password protection, the default password is automatically displayed on the password screen when you start up, and you simply press *Enter* for access to all functions of the analyzer.

4.2 Using the Data Entry and Function Buttons

Data Entry Buttons: The < > arrow buttons select options from the menu currently displayed on the VFD screen. The selected option blinks.

When the selected option includes a modifiable item, the $\Delta\nabla$ arrow buttons can be used to increment or decrement that modifiable item.

The *Enter* button is used to accept any new entries on the VFD screen. The *Escape* button is used to abort any new entries on the VFD screen that are not yet accepted by use of the *Enter* button.

Figure 4-1 shows the hierarchy of functions available to the operator via the function buttons. The six function buttons on the analyzer are:

- *Analyze*. This is the normal operating mode. The analyzer monitors the oxygen content of the sample, displays the percent of oxygen, and warns of any alarm conditions.
- *System*. The system function consists of six subfunctions that regulate the internal operations of the analyzer:
 - Set LCD screen contrast **Contrast Function is *DISABLED*** (Refer to Section 1.6) 
 - Setup Auto-Cal
 - Assign Password
 - Initiate Self -Test
 - Check software version
 - View sensor output
 - Log out.
- *Zero*. Used to set up a zero calibration.
- *Span*. Used to set up a span calibration.
- *Alarms*. Used to set the alarm setpoints and determine whether each alarm will be active or defeated, HI or LO acting, latching, and/or failsafe.
- *Range*. Used to set up three analysis ranges that can be switched automatically with auto-ranging or used as individual fixed ranges.

Any function can be selected at any time by pressing the appropriate button (unless password restrictions apply). The order as presented in this manual is appropriate for an initial setup.

Each of these functions is described in greater detail in the following procedures. The VFD screen text that accompanies each operation is repro-

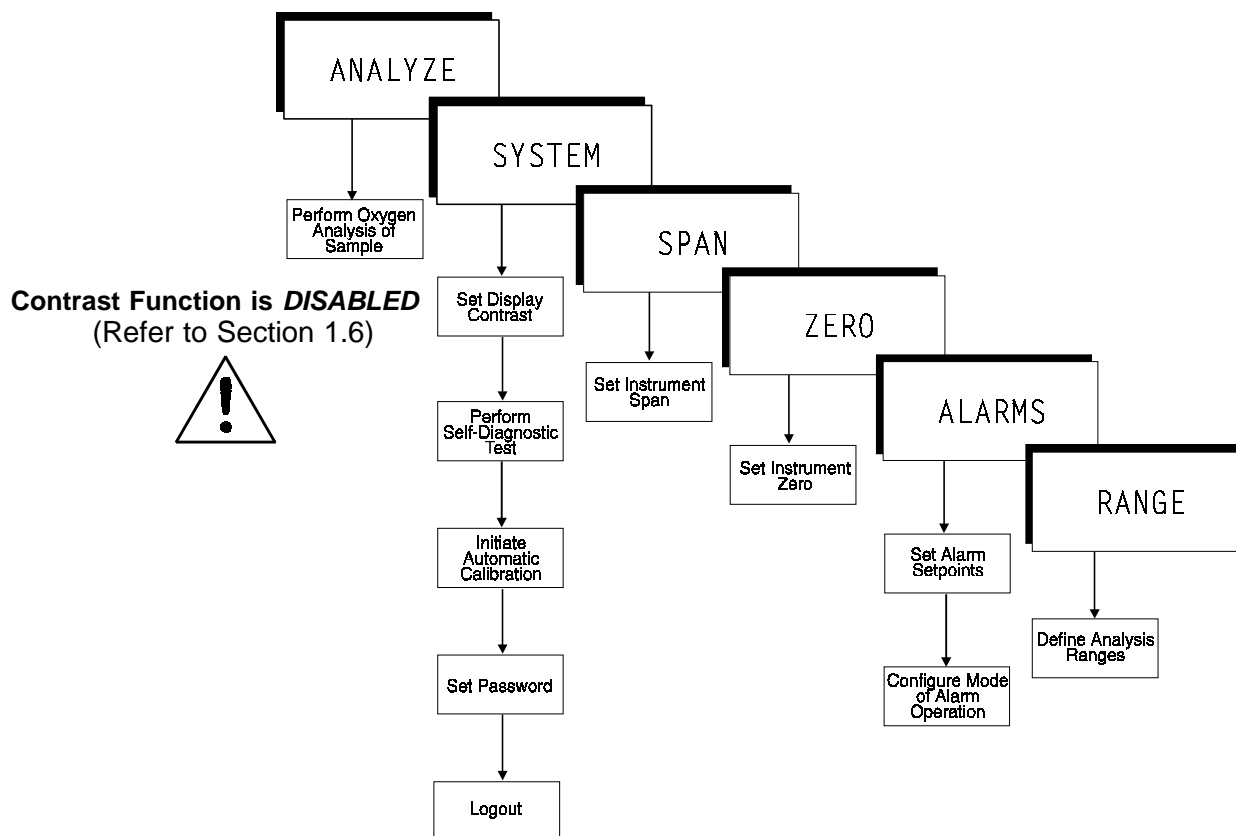

Figure 4-1: Hierarchy of Functions and Subfunctions

duced, at the appropriate point in the procedure, in a Monospaced type style. Pushbutton names are printed in *Oblique* type.

4.3 The System Function

The subfunctions of the *System* function are described below. Specific procedures for their use follow the descriptions:

- **Auto-Cal:** Used to define an automatic calibration sequence and/or start an Auto-Cal.
- **PSWD:** Security can be established by choosing a 5 digit password (PSWD) from the standard ASCII character set. (See *Installing or Changing a Password*, below, for a table of ASCII characters available.) Once a unique password is assigned and activated, the operator **MUST** enter the **UNIQUE** password to gain access to set-up functions which alter the instrument's

operation, such as setting the instrument span or zero setting, adjusting the alarm setpoints, or defining analysis ranges.

After a password is assigned, the operator must **log out** to activate it. Until then, anyone can continue to operate the instrument without entering the new password.

Only one password can be defined. Before a unique password is assigned, the system assigns TBEAL by default. This allows access to anyone. After a unique password is assigned, to defeat the security, the password must be changed back to TBEAL.

- **Logout:** Logging out prevents an unauthorized tampering with analyzer settings.
- **More:** Select and enter More to get a new screen with additional subfunctions listed.
- **Self-Test:** The instrument performs a self-diagnostic test to check the integrity of the power supply, output boards and amplifiers.
- **Version:** Displays Manufacturer, Model, and Software Version of instrument.

4.3.1 Setting the Display

Contrast Function is *DISABLED*
(Refer to Section 1.6)



If you cannot read anything on the display after first powering up:

1. Observe LED readout.
 - a. If LED meter reads all **eights and periods**, go to step 3.
 - b. If LED meter displays anything else, go to step 2.
2. Press  button twice to turn Analyzer OFF and ON again. LED meter should now read all eights and periods. Go to step 3.

4.3.2 Setting up an Auto-Cal

When proper automatic valving is connected (see chapter 3, *installation*), the Analyzer can cycle itself through a sequence of steps that automatically zero and span the instrument.

Note: If you require highly accurate Auto-Cal timing, use external Auto-Cal control where possible. The internal clock in the Model 3000MA is accurate to 2-3 %. Accordingly, internally scheduled calibrations can vary 2-3 % per day.

To setup an Auto-Cal cycle:

Choose *System* from the Function buttons. The VFD will display five subfunctions.



Contrast Function is **DISABLED**
(Refer to Section 1.6)

Contrast Auto-Cal
PSWD Logout More

Use < > arrows to blink Auto-Cal, and press *Enter*. A new screen for Span/Zero set appears.

Span OFF Nxt: 0d 0h
Zero OFF Nxt: 0d 0h

Press < > arrows to blink Span (or Zero), then press *Enter* again. (*You won't be able to set OFF to ON if a zero interval is entered.*) A Span Every ... (or Zero Every ...) screen appears.

Span Every 0 d
Start 0 h from now

Use $\Delta\nabla$ arrows to set an interval value, then use < > arrows to move to the start-time value. Use $\Delta\nabla$ arrows to set a start-time value.

To turn ON the Span and/or Zero cycles (to activate Auto-Cal): Press *System* again, choose Auto-Cal, and press *Enter* again. When the Span/Zero screen appears, use the < > arrows to blink the Span (or Zero) OFF / ON field. Use $\Delta\nabla$ arrows to set the OFF / ON field to ON. You can now turn these fields ON because there is a nonzero span interval defined.

4.3.3 Password Protection

If a password is assigned, then setting the following system parameters can be done only after the password is entered: **span** and **zero** settings, **alarm** setpoints, analysis **range** definitions, switching between **autoranging** and manual override, setting up an **auto-cal**, and assigning a new **password**. However, the instrument can still be used for analysis or for initiating a self-test without entering the password.

If you have decided not to employ password security, use the default password TBEAI. This password will be displayed automatically by the microprocessor. The operator just presses the Enter key to be allowed total access to the instrument's features.

NOTE: If you use password security, it is advisable to keep a copy of the password in a separate, safe location.

4.3.3.1 Entering the Password

To install a new password or change a previously installed password, you must key in and *ENTER* the old password first. If the default password is in effect, pressing the *ENTER* button will enter the default TBEAI password for you.

Press *System* to enter the *System* mode.

Contrast Auto-Cal
PSWD Logout More

Contrast Function is **DISABLED**
(Refer to Section 1.6)



Use the < > arrow keys to scroll the blinking over to PSWD, and press *Enter* to select the password function. Either the default TBEAI password or AAAAA place holders for an existing password will appear on screen depending on whether or not a password has been previously installed.

T B E A I
Enter PWD

or
A A A A A
Enter PWD

The screen prompts you to enter the current password. If you are not using password protection, press *Enter* to accept TBEAI as the default password. If a password has been previously installed, enter the password using the < > arrow keys to scroll back and forth between letters, and the Δ ∇ arrow keys to change the letters to the proper password. Press *Enter* to enter the password.

If the password is accepted, the screen will indicate that the password restrictions have been removed and you have clearance to proceed.

PSWD Restri cti ons
Removed

In a few seconds, you will be given the opportunity to change this password or keep it and go on.

Change Password?
 <ENT>=Yes <ESC>=No

Press *Escape* to move on, or proceed as in *Changing the Password*, below.

4.3.3.2 Installing or Changing the Password

If you want to install a password, or change an existing password, proceed as above in *Entering the Password*. When you are given the opportunity to change the password:

Change Password?
 <ENT>=Yes <ESC>=No

Press *Enter* to change the password (either the default TBEAI or the previously assigned password), or press *Escape* to keep the existing password and move on.

If you chose *Enter* to change the password, the password assignment screen appears.

T B E A I
 <ENT> To Proceed

or

A A A A A
 <ENT> To Proceed

Enter the password using the < > arrow keys to move back and forth between the existing password letters, and the $\Delta\nabla$ arrow keys to change the letters to the new password. The full set of 94 characters available for password use are shown in the table below.

Characters Available for Password Definition:

A	B	C	D	E	F	G	H	I	J
K	L	M	N	O	P	Q	R	S	T
U	V	W	X	Y	Z	[¥]	^
_	`	a	b	c	d	e	f	g	h
i	j	k	l	m	n	o	p	q	r
s	t	u	v	w	x	y	z	{	
}	→	!	"	#	\$	%	&	'	(
)	*	+	,	-	.	/	0	1	2
3	4	5	6	7	8	9	:	;	<
=	>	?	@						

When you have finished typing the new password, press *Enter*. A verification screen appears. The screen will prompt you to retype your password for verification.

A A A A A
Retype PWD To Veri fy

Wait a moment for the entry screen. You will be given clearance to proceed.

A A A A A
<ENT> TO Proceed

Use the arrow keys to retype your password and press *Enter* when finished. Your password will be stored in the microprocessor and the system will immediately switch to the *Analyze* screen, and you now have access to all instrument functions.

If all alarms are defeated, the *Analyze* screen appears as:

0.0 % Anl z
Range: 0 – 10

If an alarm is tripped, the second line will change to show which alarm it is:

0.0 % Anl z
AL-1

Note: If you log off the system using the logout function in the system menu, you will now be required to re-enter the password to gain access to Span, Zero, Alarm, and Range functions.

4.3.4 Logout

The Logout function provides a convenient means of leaving the analyzer in a password protected mode without having to shut the instrument off. By entering Logout, you effectively log off the instrument leaving the system protected against use until the password is reentered. To log out, press the *System* button to enter the *System* function.

Contrast Auto-Cal Contrast Function is **DISABLED**
PSWD Logout More (Refer to Section 1.6)



Use the < > arrow keys to position the blinking over the Logout function, and press *Enter* to Log out. The screen will display the message:

Protected Unti l
Password Reentered

4.3.5 System Self-Diagnostic Test

The Model 3000MB has a built-in self-diagnostic testing routine. Pre-programmed signals are sent through the power supply, output board and sensor circuit. The return signal is analyzed, and at the end of the test the status of each function is displayed on the screen, either as OK or as a number between 1 and 3. (See *System Self Diagnostic Test* in chapter 5 for number code.)

The self diagnostics are run automatically by the analyzer whenever the instrument is turned on, but the test can also be run by the operator at will. To initiate a self diagnostic test during operation:

Press the *System* button to start the *System* function.



Contrast Function is *DISABLED* Contrast Auto-Cal
(Refer to Section 1.6) PSWD Logout More

Use the < > arrow keys to blink More, then press *Enter*.

Versi on Sel f-Test
Cel l Output: ### μ A

Use the < > arrow keys again to move the blinking to the Self-Test function. The screen will follow the running of the diagnostic.

RUNNING DIAGNOSTIC
Testi ng Preamp – 83

During preamp testing there is a countdown in the lower right corner of the screen. When the testing is complete, the results are displayed.

Power: OK Anal og: OK
Preamp: 3

The module is functioning properly if it is followed by OK. A number indicates a problem in a specific area of the instrument. Refer to Chapter 5 *Maintenance and Troubleshooting* for number-code information. The results screen alternates for a time with:

Press Any Key
To Conti nue. . .

Then the analyzer returns to the initial System screen.

4.3.6 Version Screen

Move the < > arrow key to More and press *Enter*. With Version blinking, press *Enter*. The screen displays the manufacturer, model, and software version information.

4.4 The *Span* Functions

The analyzer is calibrated using span gas.

NOTE: *Zero is not necessary for Percent (%) level measurements.*

Additional information on Zero functions is provided in the Appendix A-4 of this manual.

Although the instrument can be spanned using air, a span gas with a known oxygen concentration in the range of 70–90% of full scale of the range of interest is recommended.

Connect the calibration gases to the analyzer according to the instructions given in Section 3.4.1, *Gas Connections*, observing all the prescribed precautions.

Shut off the gas pressure before connecting it to the analyzer, and be sure to limit the pressure to 15 psig or less when turning it back on.



Readjust the gas pressure into the analyzer until the flowrate (as read on the analyzer's flowmeter) settles between 300-900 CC/MIN.

If you are using password protection, you will need to enter your password to gain access to either of these functions. Follow the instructions in section 4.3.3 to enter your password. Once you have gained clearance to proceed, you can enter the *Zero* or *Span* function.

4.4.1 Span Cal

The *Span* button on the front panel is used to span calibrate the analyzer. Span calibration can be performed using the **automatic** mode, where an internal algorithm compares consecutive readings from the sensor to determine when the output matches the span gas concentration. Span calibration can also be performed **manual** mode, where the operator determines when the span concentration reading is acceptable and then manually exits the function.

4.4.1.1 Auto Mode Spanning

Press *Span* to enter the span function. The screen that appears allows you to select whether the span calibration is to be performed automatically or manually. Use the Δ / ∇ arrow keys to toggle between AUTO and MAN span settling. Stop when AUTO appears, blinking, on the display.

Span: Settling: AUTO
<ENT> For Next

Press *Enter* to move to the next screen.

```
Span Val : 20.90
<ENT>Span <UP>Mod #
```

Use the $\Delta\nabla$ arrow keys to enter the oxygen-concentration mode. Use the < > arrow keys to blink the digit you are going to modify. Use the $\Delta\nabla$ arrow keys again to change the value of the selected digit. When you have finished typing in the concentration of the span gas you are using (20.90 if you are using air), press *Enter* to begin the Span calibration.

```
####    %  Span
Slope=####  ppm/s
```

The beginning span value is shown in the upper left corner of the display. As the span reading settles, the screen displays and updates information on Slope. Spanning automatically ends when the slope is less than 1/50 of the displayed value of the oxygen concentration (in ppm) for three minutes. Then the instrument automatically returns to the analyze mode.

4.4.1.2 Manual Mode Spanning

Press *Span* to start the *Span* function. The screen that appears allows you to select whether the span calibration is to be performed automatically or manually.

```
Span: Settling: MAN
<ENT> For Next
```

Use the $\Delta\nabla$ keys to toggle between AUTO and MAN span settling. Stop when MAN appears, blinking, on the display. Press *Enter* to move to the next screen.

```
Span Val : 20.90
<ENT>Span <UP>Mod #
```

Press Δ (<UP>) to permit modification (Mod #) of span value.

Use the arrow keys to enter the oxygen concentration of the span gas you are using (20.90 if you are using air). The < > arrows chose the digit, and the $\Delta\nabla$ arrows choose the value of the digit.

Press *Enter* to enter the span value into the system and begin the span calibration.

Once the span has begun, the microprocessor samples the output at a predetermined rate. It calculates the difference between successive samplings and displays this difference as Slope on the screen. It takes several seconds

for the first SI ope value to display. SI ope indicates rate of change of the Span reading. It is a sensitive indicator of stability.

```
####          % Span
SI ope=####   ppm/s
```

When the Span value displayed on the screen is sufficiently stable, press *Enter*. (Generally, when the Span reading changes by 1 % or less of the full scale of the range being calibrated for a period of five minutes it is sufficiently stable.) Once *Enter* is pressed, the Span reading changes to the correct value. The instrument then automatically enters the *Analyze* function.

4.5 The Alarms Function

The Model 3000MB is equipped with 2 fully adjustable concentration alarms and a system failure alarm. Each alarm has a relay with a set of form "C" contacts rated for 3 amperes resistive load at 250 V ac. See Figure in Chapter 3, *Installation* and/or the Interconnection Diagram included at the back of this manual for relay terminal connections.

The system failure alarm has a fixed configuration described in chapter 3 *Installation*.

The concentration alarms can be configured from the front panel as either *high* or *low* alarms by the operator. The alarm modes can be set as *latching* or *non-latching*, and either *failsafe* or *non-failsafe*, or, they can be *defeated* altogether. The setpoints for the alarms are also established using this function.

Decide how your alarms should be configured. The choice will depend upon your process. Consider the following four points:

1. Which if any of the alarms are to be high alarms and which if any are to be low alarms?

Setting an alarm as HIGH triggers the alarm when the oxygen concentration rises above the setpoint. Setting an alarm as LOW triggers the alarm when the oxygen concentration falls below the setpoint.

Decide whether you want the alarms to be set as:

- Both high (high and high-high) alarms, or
 - One high and one low alarm, or
 - Both low (low and low-low) alarms.
2. Are either or both of the alarms to be configured as failsafe?

In failsafe mode, the alarm relay de-energizes in an alarm condition. For non-failsafe operation, the relay is energized in an alarm condition. You can set either or both of the concentration alarms to operate in failsafe or non-failsafe mode.

3. Are either of the alarms to be latching?

In latching mode, once the alarm or alarms trigger, they will remain in the alarm mode even if process conditions revert to non-alarm conditions. This mode requires an alarm to be recognized before it can be reset. In the non-latching mode, the alarm status will terminate when process conditions revert to non-alarm conditions.

4. Are either of the alarms to be defeated?

The defeat alarm mode is incorporated into the alarm circuit so that maintenance can be performed under conditions which would normally activate the alarms.

The defeat function can also be used to reset a latched alarm. (See procedures, below.)

If you are using password protection, you will need to enter your password to access the alarm functions. Follow the instructions in section 4.3.3 to enter your password. Once you have clearance to proceed, enter the *Alarm* function.

Press the *Alarm* button on the front panel to enter the *Alarm* function. Make sure that AL-1 is blinking.

```
AL-1      AL-2
Choose AI arm
```

Set up alarm 1 by moving the blinking over to AL-1 using the < > arrow keys. Then press *Enter* to move to the next screen.

```
AL-1 1.00 % HI
Dft-N Fs-N Ltch-N
```

Five parameters can be changed on this screen:

- Value of the alarm setpoint, AL-1 ##### % (oxygen)
- Out-of-range direction, HI or LO
- Defeated? Dft-Y/N (Yes/No)
- Failsafe? Fs-Y/N (Yes/No)
- Latching? Ltch-Y/N (Yes/No).

- To define the setpoint, use the < > arrow keys to move the blinking over to AL-1 ####. Then use the Δ ∇ arrow keys to change the number. Holding down the key speeds up the incrementing or decrementing. (Remember, the setpoint units are percent-of-oxygen.)
- To set the other parameters use the < > arrow keys to move the blinking over to the desired parameter. Then use the Δ ∇ arrow keys to change the parameter.
- Once the parameters for alarm 1 have been set, press *Alarms* again, and repeat this procedure for alarm 2 (AL-2).
- To reset a latched alarm, go to Dft- and then press either Δ two times or ∇ two times. (Toggle it to Y and then back to N.)

-OR -

Go to Ltch- and then press either Δ two times or ∇ two times.
(Toggle it to N and back to Y.)

4.6 The *Range* Function

The Range function allows the operator to program up to three concentration ranges to correlate with the DC analog outputs. If no custom ranges are defined by the user, the instrument defaults to:

Low = 0-1.00 %
Med = 0-5.00 %
High = 0-10.00 %.

The Model 3000MB is set at the factory to default to autoranging. In this mode, the microprocessor automatically responds to concentration changes by switching ranges for optimum readout sensitivity. If the current range limits are exceeded, the instrument will automatically shift to the next higher range. If the concentration falls slightly below full scale of the next lower range, the instrument will switch to that range. A corresponding shift in the DC percent-of-range output, and in the range ID outputs, will be noticed.

The autoranging feature can be overridden so that analog output stays on a fixed range regardless of the oxygen concentration detected. If the concentration exceeds the upper limit of the range, the DC output will saturate at 1 V dc.

However, the digital readout and the RS-232 output of the concentration are unaffected by the fixed range. They continue to read accurately with full precision. See *Front Panel* description in Chapter 1.

4.6.1 Setting the Analog Output Ranges

To set the ranges, enter the range function mode by pressing the *Range* button on the front panel.

L-1.00 M-5.00
H-10.00 Mode-AUTO

Use the < > arrow keys to blink the range to be set: low (L), medium (M), or high (H).

Use the $\Delta \nabla$ arrow keys to enter the upper value of the range (all ranges begin at 0 %). Repeat for each range you want to set. Press *Enter* to accept the values and return to *Analyze* mode. (See note below.)

Note: The ranges must be increasing from low to high. For example, if range 1 is set as 0–1 % and range 2 is set as 0–10 %, range 3 cannot be set as 0–5 % since it is lower than range 2.

4.6.2 Autoranging Analysis

Set your analysis ranges as in 4.6.1, above. Leave Mode in Auto, or use the arrow buttons to change back to Auto.

When operating in autoranging, if the oxygen concentration in your sample goes ABOVE your HIGHEST range setting, the analyzer will go into the special 25 % cal range.

However, if one of your range settings is below 0-25 % and another is set above 0-25 %, the special 0-25 % Air Cal range will NOT activate as the oxygen level goes through 25 %. Nevertheless, if the oxygen concentration in your sample goes ABOVE your HIGHEST range setting, the analyzer will THEN drop back down into the special 25 % cal range.

Once the oxygen concentration drops back down into your highest range setting, the analyzer will automatically switch back to that range.

CAUTION: While the analyzer is in the Air Cal range, the oxygen reading cannot go over 25 %, even if the oxygen concentration is higher than 25 %.



4.6.3 Fixed Range Analysis

The autoranging mode of the instrument can be overridden, forcing the analyzer DC outputs to stay in a single predetermined range.

To switch from autoranging to fixed range analysis, enter the range function by pressing the *Range* button on the front panel.

Use the < > arrow keys to move the blinking over AUTO.

Use the $\Delta \nabla$ arrow keys to switch from AUTO to FX/LO, FX/MED, or FX/ HI to set the instrument on the desired fixed range (low, medium, or high).

```
L-1.00  M-5.00
H-10.00 Mode-FX/LO
```

or

```
L-1.00  M-5.00
H-10.00 Mode-FX/MED
```

or

```
L-1.00  M-5.00
H-10.00 Mode-FX/HI
```

Press *Escape* to re-enter the *Analyze* mode using the fixed range.

NOTE:When performing analysis on a fixed range, if the oxygen concentration rises above the upper limit (or default value) as established by the operator for that particular range, the output saturates at 1 V dc. However, the digital readout and the RS-232 output continue to read the true value of the oxygen concentration regardless of the analog output range.

4.7 The *Analyze* Function

Normally, all of the functions automatically switch back to the *Analyze* function when they have completed their assigned operations. Pressing the *Escape* button in many cases also switches the analyzer back to the *Analyze* function. Alternatively, you can press the *Analyze* button at any time to return to analyzing your sample.

4.8 Signal Output

The standard Model 3000MB Percent Oxygen Analyzer is equipped with two 0–1 V dc analog output terminals accessible on the back panel (one concentration and one range ID). The –MA option also has two isolated 4–20 mA dc current outputs (one concentration and one range ID).

See *Rear Panel* in Chapter 3, *Installation*, for illustration.

The signal output for concentration is linear over the currently selected analysis range. For example, if the analyzer is set on range that was defined as 0–10 % O₂, then the output would be:

% O ₂	Voltage Signal Output (V dc)	Current Signal Output (mA dc)
0	0.0	4.0
1	0.1	5.6
2	0.2	7.2
3	0.3	8.8
4	0.4	10.4
5	0.5	12.0
6	0.6	13.6
7	0.7	15.2
8	0.8	16.8
9	0.9	18.4
10	1.0	20.0

The analog output signal has a voltage which depends on the oxygen concentration AND the currently activated analysis range. To relate the signal output to the actual concentration, it is necessary to know what range the instrument is currently on, especially when the analyzer is in the autoranging mode.

To provide an indication of the range, a second pair of analog output terminals are used. They generate a steady preset voltage (or current if you have current outputs) to represent a particular range. The following table gives the range ID output for each analysis range:

Range	Voltage (V)	Current (mA)
LO	0.25	8
MED	0.50	12
HI	0.75	16
CAL (0-25%)	1.00	20

5.0 Maintenance

Aside from normal cleaning and checking for leaks at the gas connections, routine maintenance is limited to replacing filter elements and fuses, and recalibration.



WARNING: SEE WARNINGS ON THE TITLE PAGE OF THIS MANUAL.



5.1 Replacing the Fuse

Remove Power to Unit before replacing the fuse.

- Push and turn the Fuse Holder 1/2 turn to the left.
- Remove the old fuse, and
- Assemble in the new fuse in reverse order

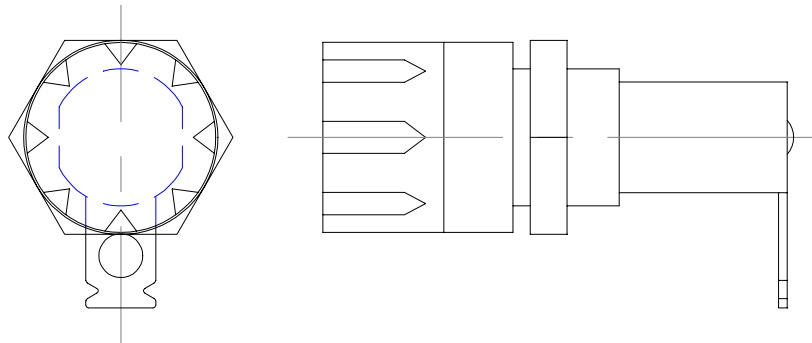

Figure 5-1: Fuse holder, 3AG Type

5.2 System Self Diagnostic Test

1. Press the *system* button to enter the system mode
2. Use the < > arrow keys to move to *More*, and press *Enter*.
3. Use the < > arrow keys to move to *Self-Test*, and press *Enter*.

The following failure codes apply:

Table 5.2: Self-Test Failure Codes

Power

OK

- 1 5V Failure
- 2 15V Failure
- 3 Both Failed

Analog

OK

- 1 DAC A (0-1V Concentration)
- 2 DAC B (0-1V Range ID)
- 3 Both Failed

Preamp

OK

- 1 Zero too High
- 2 Amplifier dosen't match test input
- 3 Both Failed

5.3 Major Internal Components

The paramagnetic cell, and other internal components are accessed by opening the front door, and unlatching and swinging open the front panel, as described earlier.

Warnings: See warnings on the title page of this manual for details.

The 3000MB contains the following major components:

Paramagnetic Sensor

2 x Power Supplies

Microprocessor

Displays

5 Digit, LED Meter.

2 line, 20 character, alphanumeric, VFD display.

5.4 Cleaning

If the instrument is unmounted at the time of cleaning, disconnect the instrument from its power source. Close and latch the front panel, and front door. Clean outside surfaces with a soft cloth dampened slightly with plain clean water. Do not use harsh solvents such as paint thinner or benzene.

For mounted instruments, clean the front panel as described in the above paragraph. DO NOT wipe front panel while the instrument is controlling your process.

5.5 Troubleshooting

Problem:

Erratic reading of the oxygen concentration by the analyzer.

Possible Cause:

The analyzer may have been calibrated in an inaccurate fashion.

Solution:

Turn the analyzer off, then back on again. Press the System key when prompted by the analyzer "press system for default values". This will return your analyzer to its default settings in calibration and zero values. If erratic behavior continues replace the sensor.

Possible Cause:

Atmospheric Oxygen may be diffusing in through the vent, and affecting the oxygen level which the sensor sees.

Solution:

Increase the flow rate and/or length of tubing in order to dilute or minimize the diffusion of oxygen from the vent back to the analyzer.

Problem:

Inaccurate zero operation (i.e. the user has zeroed the analyzer accidentally on gas much higher than one would normally use for zero gas).

Solution:

Turn the analyzer off, then back on again. Press the system key when prompted by the analyzer "press system for default values". This will return the analyzer to its default settings in calibration and zero values. Now proceed to carefully calibrate and zero the analyzer.

Appendix

A-1 Model 3000MB Specifications

Packaging: General Purpose

- Nema 4 rated bulkhead mount enclosure.

Sensor: Paramagnetic Sensor

90 % Response Time: 10 seconds at 25 °C (77 °F).

Ranges: Three user definable ranges from 0-1 % to 0-100 %, plus air calibration range of 0-25 %.

Alarms: One system-failure alarm contact to detect power failure.

Two adjustable concentration threshold alarms with fully programmable setpoints.

Displays: 2 line by 20 character, alphanumeric, VFD screen.
One 5 digit LED display.

Digital Interface: Full duplex RS-232 communications port.

Power: Universal power supply 100-240 VAC, at 50/60 Hz.

Operating Temperature: 0-45 °C (32-113 °F).

Accuracy: ±1% of full scale at constant temperature.
±5% of full scale over operating temperature range, on factory default analysis ranges, once thermal equilibrium has been reached.

Analog outputs: 0-1 V dc percent-of-range (Standard)
 0-1 V dc range ID (Standard)
 4-20 mA dc—isolated— percent-of-range
 (Optional)
 4-20 mA dc—isolated— range ID (Optional)

Dimensions: 20.5" High x 13" Wide x 9" Tall
 (52.1 cm x 33 cm x 22.9 cm)

A-2 Recommended 2-Year Spare Parts List

Qty	PartNumber	Description
1	C62374	Back Panel Board
1	C62371-B	Front Panel Board
1	C670043	Percent Preamplifier Board
1*	C62365-C	Main Computer Board (std)
1*	C62365-A	Main Computer Board (4-20 mA)
3	F10	Fuse, 2 A, 250 V, 3 AG, Slow Blow
2	F73	Ferrule 1/4" SS
2	F74	Ferrule 1/4" SS
2	N73	Nut 1/4" SS
1	A68729	Restrictor Kit
1	V11	Union SS 1/4"

NOTE: Orders for replacement parts should include the part number (if available) and the model and serial number of the instrument for which the parts are intended.

Orders should be sent to:

TELEDYNE Analytical Instruments

16830 Chestnut Street
 City of Industry, CA 91748

Phone (626) 934-1500, Fax (626) 961-2538
 TWX (910) 584-1887 TDYANYL COID

Web: www.teledyne-ai.com

or your local representative.

A-3 Drawing List

D-73375 Outline Drawing

D- 74765 Outline Drawing

D-73374 Interconnection Diagram

A-4 Zero Cal

The Zero button on the front panel is used to enter the zero calibration function. Zero calibration can be performed in either the automatic or manual mode. In the automatic mode, an internal algorithm compares consecutive readings from the sensor to determine when the output is within the acceptable range for zero. In the manual mode, the operator determines when the reading is within the acceptable range for zero. Make sure the zero gas is connected to the instrument. If zeroing is becoming more and more difficult, skip to section 4.4.1.3 Cell Failure.

A-4.1 Auto Mode Zeroing

Press Zero to enter the zero function mode. The screen allows you to select whether the zero calibration is to be performed automatically or manually. Use the DÑ arrow keys to toggle between AUTO and MAN zero settling. Stop when AUTO appears, blinking, on the display.

Zero: Settling: AUTO
<ENT> To Begin

Press *Enter* to begin zeroing.

% Zero
Slope=#### ppm/s

The beginning zero level is shown in the upper left corner of the display. As the zero reading settles, the screen displays and updates information on Slope (unless the Slope starts within the acceptable zero range and does not need to settle further).

Then, and whenever Slope is less than 0.08 for at least 3 minutes, instead of Slope you will see a countdown: 5 Left, 4 Left, and so fourth. These are five steps in the zeroing process that the system must complete, AFTER settling, before it can go back to Analyze.

% Zero
4 Left=### ppm/s

The zeroing process will automatically conclude when the output is within the acceptable range for a good zero. Then the analyzer automatically returns to the Analyze mode.

A-4.2 Manual Mode Zeroing

Press Zero to enter the Zero function. The screen that appears allows you to select between automatic or manual zero calibration. Use the DÑ keys to toggle between AUTO and MAN zero settling. Stop when MAN appears, blinking, on the display.

Zero: Settling: Man
<ENT> To Begin

Press Enter to begin the zero calibration. After a few seconds the first of five zeroing screens appears. The number in the upper left hand corner is the first-stage zero offset. The microprocessor samples the output at a predetermined rate. It calculates the differences between successive samplings and displays the rate of change as Slope= a value in parts per million per second (ppm/s).

% Zero
Slope=#### ppm/s

Note: It takes several seconds for the true Slope value to display. Wait about 10 seconds. Then, wait until Slope is sufficiently close to zero before pressing Enter to finish zeroing .

Generally, you have a good zero when Slope is less than 0.05 ppm/s for about 30 seconds. When Slope is close enough to zero, press Enter. In a few seconds, the screen will update.

Once span settling completes, the information is stored in the microprocessor, and the instrument automatically returns to the Analyze mode.

NOTES: UNLESS OTHERWISE SPECIFIED.
 1. ALL DIMENSIONS ARE IN INCHES (±.06) AND MILLIMETERS (±1.) INCHES[mm]

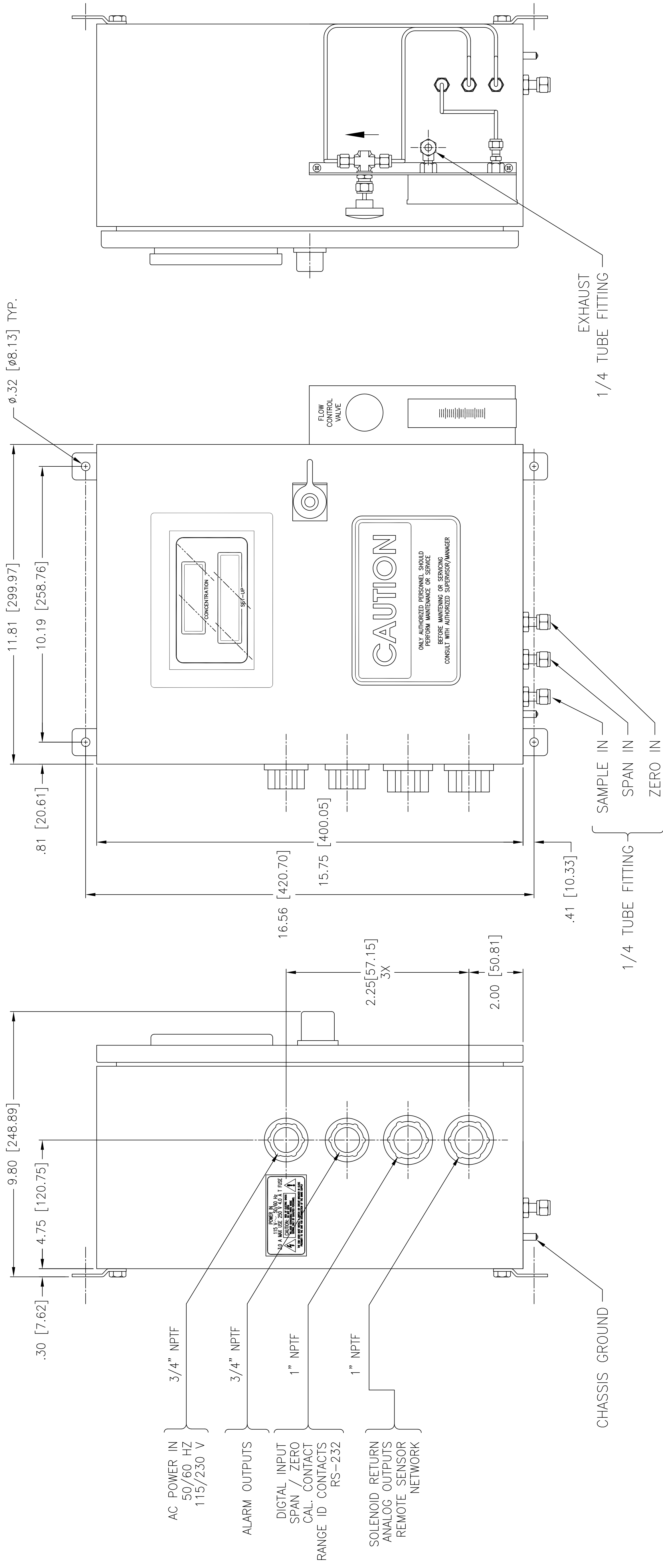

REV	DESCRIPTION	DATE	APP.	REV.
0	INITIAL RELEASE	6-5-02	TC	JCR

ITEM	QTY	PART NO.	DESCRIPTION
BILL OF MATERIAL			
DO NOT SCALE DWG TOLERANCE UNLESS OTHERWISE SPECIFIED: ANGULAR ±1/2" LINEAR .XXX = ±.02 .XXX = ±.010			
THIS DRAWING IS THE PROPERTY OF TELEDYNE ANALYTICAL INSTRUMENTS AND CONTAINS CONFIDENTIAL INFORMATION. IT IS NOT TO BE COPIED, REPRODUCED OR USED WITHOUT WRITTEN PERMISSION.			
Teledyne Analytical Instruments A business unit Teledyne Electronic Technologies CITY OF INDUSTRY, CALIFORNIA 91748			
SIGNATURES		DATE	TITLE
DRAFT: JOHN REYES		05/30/02	
CHK: V/ D-74764			
APP: P/			
ENGR: TOM CHERNIAUS			
C.O. 04-3112			
REFERENCE: F/ D-74766			
CAD ID: D74765-0			
MATERIAL		DWG. NO.	REV.
NONE		D-74765	0

N/	SCALE
D-74764	1:2
D-74764	SIM D-74752
O/	SHEET 1 OF 1
P/	
F/ D-74766	

OUTLINE DIAGRAM
 PARAMAGNETIC O2 ANALYZER
 MODEL 3000MB-CV

NOTES: UNLESS OTHERWISE SPECIFIED.

1. ALL DIMENSIONS ARE IN INCHES (±.06) AND MILLIMETERS (±1.) INCHES[mm]

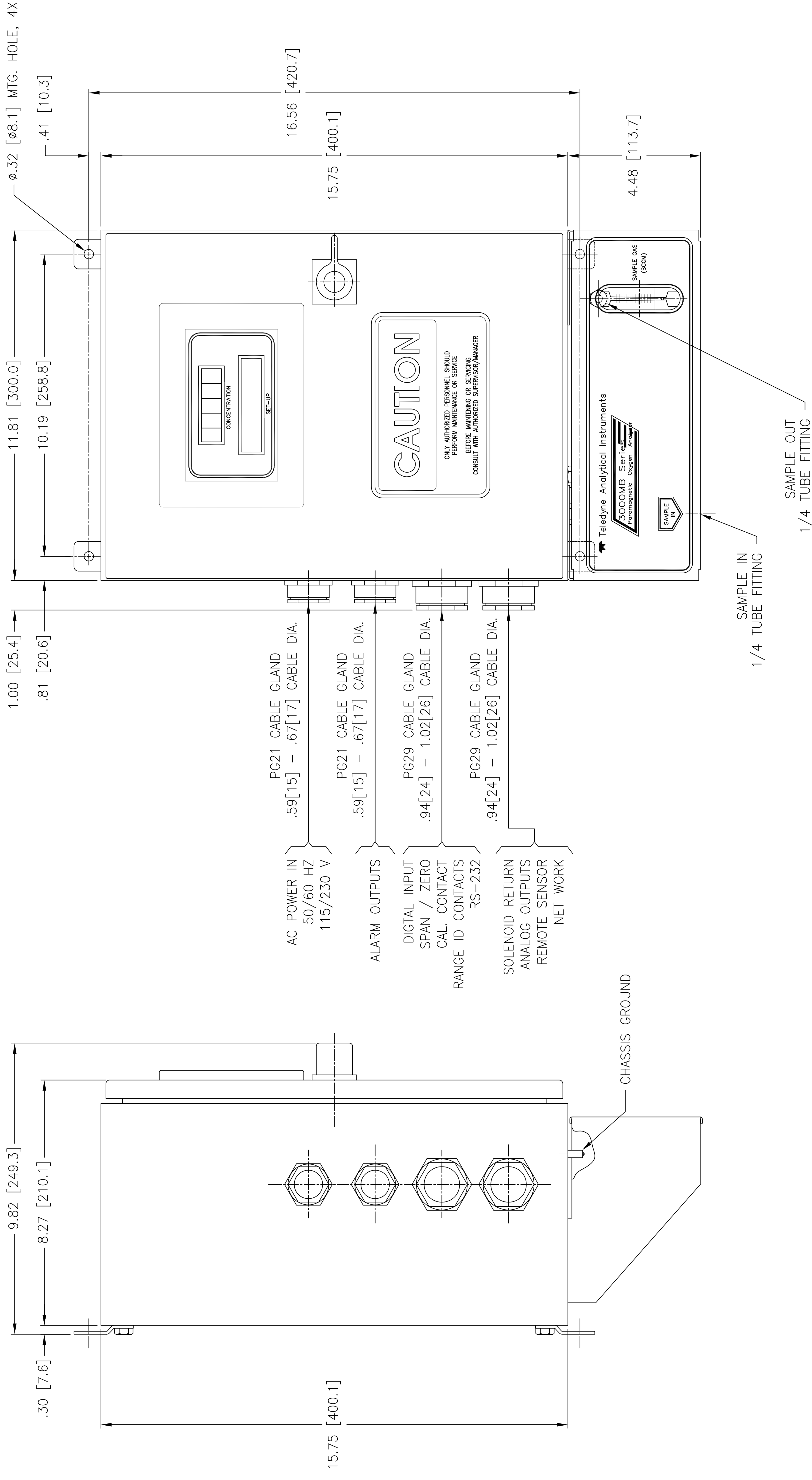

REV.	DESCRIPTION	DATE	APP.	REV. BY
0	INITIAL RELEASE	1/16/01	AA	--

DO NOT SCALE DWG.		UNLESS OTHERWISE SPECIFIED, DIMENSIONS ARE TO CENTERLINE UNLESS INDICATED OTHERWISE.	
ANGULAR	±1/2°	ANGULAR	±1/2°
LINEAR	±.010	LINEAR	±.010

SIGNATURES	DATE	TITLE	SCALE
DRFT: JOHN REYES	01/16/01	TELEDYNE INSTRUMENTS Analytical Instruments A Teledyne Technologies Company City of Industry, California, 91748, USA	1:2
CHK: I/ D-73374		OUTLINE DIAGRAM	SIM D-72934
APPR: O/		PARAMAGNETIC O2 ANALYZER	SHEET 1 OF 1
ENGR: ANGEL ALEGRIA		MODEL 3000MB	REV. 0
C.O.: 027120		DWG. NO. D-73375	
REFERENCE: CAD ID: D73375-0		MATL: NONE	

REV	DESCRIPTION	DATE	APP.	REV.
0	Initial Release	12/23/00	RF	---

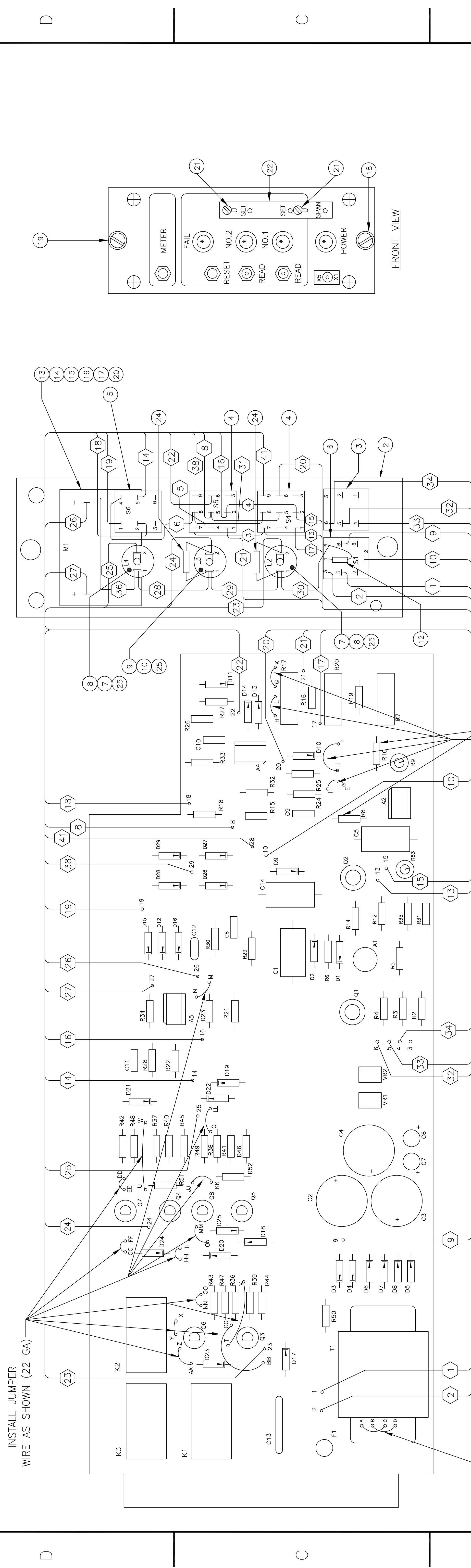

INSTALL JUMPER WIRE AS SHOWN (22 GA), ON BACK OF PCB

INSTALL JUMPER WIRE AS SHOWN (22 GA)

INSTALL JUMPER WIRE AS SHOWN (22 GA)

ITEM	QTY	DESCRIPTION	PART NO.
23	1	METER DIAL, MODIFY: 0-5%02, W/O CAL MARK	D 311
29	1	RESISTOR, 90.9K, 0.125W, 1%, M.F., LOCATION:R10	R 372
28	1	RESISTOR, 4.99K, 0.125W, 1%, M.F., LOCATION:R8	R 411
27	1	LED, AMP	L 162
26	1	LED, GREEN	L 165
25	3	LAMP HOLDER	H 196
24	2	RESISTOR, 9.09 K, 1/8 W, MF 1%	R 345
30	1	METER DIAL, MODIFY: 0-5%02, W/O CAL MARK	D 311
29	1	RESISTOR, 90.9K, 0.125W, 1%, M.F., LOCATION:R10	R 372
28	1	RESISTOR, 4.99K, 0.125W, 1%, M.F., LOCATION:R8	R 411
27	1	LED, AMP	L 162
26	1	LED, GREEN	L 165
25	3	LAMP HOLDER	H 196
24	2	RESISTOR, 9.09 K, 1/8 W, MF 1%	R 345
23	1	METER DIAL, MODIFY: 0-5%02, W/O CAL MARK	D 311
22	1	POT SHAFT COVER	A30437
21	2	SHOULDER SCREW	S 225
20	1	METER	M 177
19	1	SCREW THUMB & RETAINER	S 211
18	1	JACK SCREW & RETAINER	S 212
17	2	WASHER, No. 4 FLAT	-----
16	2	NUT, 4-40 HEX	-----
15	2	SCREW, 4-40 x 3/4" LG.	-----
14	1	METER MOUNTING ANGLE	A36670
13	1	DAIL	D 311
12	1	RESISTOR, 220Ω, 1/2 W, 25%	R 299
11	1	TAG RANGE SWITCH	A31290
10	1	LED, RED	L 161
9	1	LENS, RED	L 171
8	1	LENS, CLEAR	L 174
7	2	LED, YELLOW	L 163
6	1	SWITCH, PUSH BUTTON	S 233
5	1	SWITCH, PUSH BUTTON	S 194
4	2	SWITCH, TOGGLE	S 166
3	1	SWITCH, TOGGLE	S 132
2	1	FRONT PANEL	A30385
1	1	PC BOARD ASSEMBLY	D15483

NOTES: UNLESS OTHERWISE SPECIFIED.

1 ADD ITEMS 3 & 11

2 MODIFY METER DIAL TO READ 0-5% 02 (W/O CAL MARK, WILL USE SPAN GAS)

3 MODIFY METER DIAL TO READ REPLACE STD. RESISTORS R8 AND R10 AS FOLLOWS:
R8: 4.99K OHMS
R10: 90.9K OHMS

WIRE No.	FROM	WIRE No.	TO	COLOR
23	L2-2	TP-23	WH-OR	
22	S5-6	TP-22	WH-RD	
21	S5-1	TP-21	WH-BN	
20	S4-6	TP-20	WH-BK	
19	S6-1	TP-19	BK-WH	
18	S6-2	TP-18	BK-SL	
17	S4-1	TP-17	BK-VT	
16	S5-2	TP-16	BK-BL	
15	S4-2	TP-15	BK-BN	
14	S6-5	TP-14	BK-YL	
13	S4-7	TP-13	BK-OR	
12				
11				
10	S1-2	TP-10	BK	
9	S1-6	TP-9	WH	
8	S5-5	TP-8	SL	
7				
6	S6-4	S5-8	VT	
5	S5-8	S4-8	VT	
4	S5-2	S4-2	BK-GN	
3	S5-7	S4-7	BK-OR	
2	S1-3	TP-2	RD	
1	S1-5	TP-1	BN	
WIRE No.	FROM	WIRE No.	TO	COLOR
41	TP-28	S4-9	WH-BL	
40				
39	TP-29	S5-9	WH-VT	
38				
37				
36	L4-1	S6-4	WH	
35				
34	S2-6	TP-4	WH-BL	
33	S2-4	TP-5	WH-SL	
32	S2-5	TP-6	WH-VT	
31	S5-5	S4-5	SL	
30	L2-1	S1-4	WH	
29	L3-1	L2-1	WH	
28	L4-1	L3-1	WH	
27	M1(+)	TP-27	OR-RD	
26	M1(-)	TP-26	OR-BK	
25	L4-2	TP-25	WH-GN	
24	L3-2	TP-24	WH-YL	
23	FROM	TO	COLOR	

SCHEMATIC: D-73348
CODE: 1 MH (AMB) S, 2 MH (RED) S, FS, M (R 0-5, 0-25%, NO CAL MARK), S.B., 110VAC

DO NOT SCALE DWG
TOLERANCE UNLESS OTHERWISE SPECIFIED: ANGULAR ±1/2°
LINEAR ±.010

THE DRAWING IS THE PROPERTY OF TELEDYNE ANALYTICAL INSTRUMENTS AND CONTAINS CONFIDENTIAL INFORMATION. IT IS NOT TO BE COPIED, REPRODUCED OR USED WITHOUT WRITTEN PERMISSION.

Teledyne Analytical Instruments
A business unit of Teledyne Electronic Technologies
CITY OF INDUSTRY, CALIFORNIA 91748

WIRING ASSEMBLY (W/METER)
FRONT PANEL TO PCB
MODEL 322 CHANNEL MODULE

SCALE: NTS
SHEET: D-71617
1 OF 1

AS LISTED
DWG NO. D-73347

BILL OF MATERIAL

ITEM	QTY	DESCRIPTION	PART NO.
23	1	METER DIAL, MODIFY: 0-5%02, W/O CAL MARK	D 311
29	1	RESISTOR, 90.9K, 0.125W, 1%, M.F., LOCATION:R10	R 372
28	1	RESISTOR, 4.99K, 0.125W, 1%, M.F., LOCATION:R8	R 411
27	1	LED, AMP	L 162
26	1	LED, GREEN	L 165
25	3	LAMP HOLDER	H 196
24	2	RESISTOR, 9.09 K, 1/8 W, MF 1%	R 345

BILL OF MATERIAL

ITEM	QTY	DESCRIPTION	PART NO.
23	1	METER DIAL, MODIFY: 0-5%02, W/O CAL MARK	D 311
22	1	POT SHAFT COVER	A30437
21	2	SHOULDER SCREW	S 225
20	1	METER	M 177
19	1	SCREW THUMB & RETAINER	S 211
18	1	JACK SCREW & RETAINER	S 212
17	2	WASHER, No. 4 FLAT	-----
16	2	NUT, 4-40 HEX	-----
15	2	SCREW, 4-40 x 3/4" LG.	-----
14	1	METER MOUNTING ANGLE	A36670
13	1	DAIL	D 311
12	1	RESISTOR, 220Ω, 1/2 W, 25%	R 299
11	1	TAG RANGE SWITCH	A31290
10	1	LED, RED	L 161
9	1	LENS, RED	L 171
8	1	LENS, CLEAR	L 174
7	2	LED, YELLOW	L 163
6	1	SWITCH, PUSH BUTTON	S 233
5	1	SWITCH, PUSH BUTTON	S 194
4	2	SWITCH, TOGGLE	S 166
3	1	SWITCH, TOGGLE	S 132
2	1	FRONT PANEL	A30385
1	1	PC BOARD ASSEMBLY	D15483