

Use and Disclosure of Data
Information contained herein is classified as EAR99 under the
U.S. Export Administration Regulations.
Export, reexport or diversion contrary to U.S. law is prohibited.



OPERATING INSTRUCTIONS FOR

MODEL 3000TB

Trace Oxygen Analyzer



P/N M66673
10/06/17

 **DANGER** 

HIGHLY TOXIC AND OR FLAMMABLE LIQUIDS OR GASES MAY BE PRESENT IN THIS MONITORING SYSTEM.

PERSONAL PROTECTIVE EQUIPMENT MAY BE REQUIRED WHEN SERVICING THIS SYSTEM.

HAZARDOUS VOLTAGES EXIST ON CERTAIN COMPONENTS INTERNALLY WHICH MAY PERSIST FOR A TIME EVEN AFTER THE POWER IS TURNED OFF AND DISCONNECTED.

ONLY AUTHORIZED PERSONNEL SHOULD CONDUCT MAINTENANCE AND/OR SERVICING. BEFORE CONDUCTING ANY MAINTENANCE OR SERVICING CONSULT WITH AUTHORIZED SUPERVISOR/MANAGER.

DECLARATION OF CONFORMITY

APPLICATION OF COUNCIL DIRECTIVE : 89 / 336 / EEC
73/23/EEC

STANDARDS TO WHICH CONFORMITY IS DECLARED : EN55011-Class A Group I
EN50082-2
EN61010-1

MANUFACTURER'S NAME : TELEDYNE ANALYTICAL INSTRUMENTS

MANUFACTURER'S ADDRESS : 16830 Chestnut Street
City of Industry, CA 91748-1020
U.S.A.

TYPE OF EQUIPMENT : Oxygen Analyzer

EQUIPMENT CLASS : ISM Class A Group 1

MODEL NUMBER : 3000TB

I, THE UNDERSIGNED, HEREBY DECLARE THAT THE EQUIPMENT SPECIFIED ABOVE CONFORMS TO THE ABOVE STANDARD(S) PER 89 / 336 / EEC AND 73 / 23 / EEC.

PLACE: City of Industry, CA

SIGNATURE: 

FULL NAME: Stephen Broy

POSITION: Engineering Manager

Copyright © 2017 Teledyne Analytical Instruments

All Rights Reserved. No part of this manual may be reproduced, transmitted, transcribed, stored in a retrieval system, or translated into any other language or computer language in whole or in part, in any form or by any means, whether it be electronic, mechanical, magnetic, optical, manual, or otherwise, without the prior written consent of Teledyne Analytical Instruments, 16830 Chestnut Street, City of Industry, CA 91748.

Warranty

This equipment is sold subject to the mutual agreement that it is warranted by us free from defects of material and of construction, and that our liability shall be limited to replacing or repairing at our factory (without charge, except for transportation), or at customer plant at our option, any material or construction in which defects become apparent within one year from the date of shipment, except in cases where quotations or acknowledgements provide for a shorter period. Components manufactured by others bear the warranty of their manufacturer. This warranty does not cover defects caused by wear, accident, misuse, neglect or repairs other than those performed by Teledyne or an authorized service center. We assume no liability for direct or indirect damages of any kind and the purchaser by the acceptance of the equipment will assume all liability for any damage which may result from its use or misuse.

We reserve the right to employ any suitable material in the manufacture of our apparatus, and to make any alterations in the dimensions, shape or weight of any parts, in so far as such alterations do not adversely affect our warranty.

Important Notice

This instrument provides measurement readings to its user, and serves as a tool by which valuable data can be gathered. The information provided by the instrument may assist the user in eliminating potential hazards caused by his process; however, it is essential that all personnel involved in the use of the instrument or its interface, with the process being measured, be properly trained in the process itself, as well as all instrumentation related to it.

The safety of personnel is ultimately the responsibility of those who control process conditions. While this instrument may be able to provide early warning of imminent danger, it has no control over process conditions, and it can be misused. In particular, any alarm or control systems installed must be tested and understood, both as to how they operate and as to how they can be defeated. Any safeguards required such as locks, labels, or redundancy, must be provided by the user or specifically requested of Teledyne at the time the order is placed.

Therefore, the purchaser must be aware of the hazardous process conditions. The purchaser is responsible for the training of personnel, for providing hazard warning methods and instrumentation per the appropriate standards, and for ensuring that hazard warning devices and instrumentation are maintained and operated properly.

Teledyne Analytical Instruments, the manufacturer of this instrument, cannot accept responsibility for conditions beyond its knowledge and control. No statement expressed or implied by this document or any information disseminated by the manufacturer or its agents, is to be construed as a warranty of adequate safety control under the user's process conditions.

Specific Model Information

The instrument for which this manual was supplied may incorporate one or more options not supplied in the standard instrument. Commonly available options are listed below, with check boxes. Any that are incorporated in the instrument for which this manual is supplied are indicated by a check mark in the box.

Instrument Serial Number: _____

Options Included in the Instrument with the Above Serial Number:

Auto Calibration Valves:

Three gas inputs, for sample, zero and span gases, with three solenoid-actuated gas-flow control valves built in. Valves are automatically synchronized to the analyzer's electronic control sequences.

Sensor Options Available for the Instrument with the Above Serial Number:

- A2C
- B2C
- L2C

Important Notice

Model 3000TB complies with all of the requirements of the Commonwealth of Europe (CE) for Radio Frequency Interference, Electromagnetic Interference (RFI/EMI), and Low Voltage Directive (LVD).

The following International Symbols are used throughout the Instruction Manual. These symbols are visual indicators of important and immediate warnings and when you must exercise CAUTION while operating the instrument. See also the Safety Information on the next page.



STAND-BY: Instrument is on Stand-by, but circuit is active



GROUND: Protective Earth



CAUTION: The operator needs to refer to the manual for further information. Failure to do so may compromise the safe operation of the equipment.



CAUTION: Risk of Electrical Shock

Safety Messages

Your safety and the safety of others is very important. We have provided many important safety messages in this manual. Please read these messages carefully.

A safety message alerts you to potential hazards that could hurt you or others. Each safety message is associated with a safety alert symbol. These symbols are found in the manual and inside the instrument. The definition of these symbols is described below:



GENERAL WARNING/CAUTION: Refer to the instructions for details on the specific danger. These cautions warn of specific procedures which if not followed could cause bodily injury and/or damage the instrument.



CAUTION: HOT SURFACE WARNING: This warning is specific to heated components within the instrument. Failure to heed the warning could result in serious burns to skin and underlying tissue.



WARNING: ELECTRICAL SHOCK HAZARD: Dangerous voltages appear within this instrument. This warning is specific to an electrical hazard existing at or nearby the component or procedure under discussion. Failure to heed this warning could result in injury and/or death from electrocution.



No
Symbol

Technician Symbol: All operations marked with this symbol are to be performed by qualified maintenance personnel only.

NOTE: Additional information and comments regarding a specific component or procedure are highlighted in the form of a note.

CAUTION: THE ANALYZER SHOULD ONLY BE USED FOR THE PURPOSE AND IN THE MANNER DESCRIBED IN THIS MANUAL.



IF YOU USE THE ANALYZER IN A MANNER OTHER THAN THAT FOR WHICH IT WAS INTENDED, UNPREDICTABLE BEHAVIOR COULD RESULT POSSIBLY ACCOMPANIED WITH HAZARDOUS CONSEQUENCES.

This manual provides information designed to guide you through the installation, calibration and operation of your new analyzer. Please read this manual and keep it available.

Occasionally, some instruments are customized for a particular application or features and/or options added per customer requests. Please check the front of this manual for any additional information in the form of an Addendum which discusses specific information, procedures, cautions and warnings that may be peculiar to your instrument.

Manuals do get lost. Additional manuals can be obtained from Teledyne at the address given in the Appendix. Some of our manuals are available in electronic form via the internet. Please visit our website at: www.teledyne-ai.com.



This is a general purpose instrument designed for use in a nonhazardous area. It is the customer's responsibility to ensure safety especially when combustible gases are being analyzed since the potential of gas leaks always exist.

The customer should ensure that the principles of operation of this equipment are well understood by the user. Misuse of this product in any manner, tampering with its components, or unauthorized substitution of any component may adversely affect the safety of this instrument.

Since the use of this instrument is beyond the control of Teledyne, no responsibility by Teledyne, its affiliates, and agents for damage or injury from misuse or neglect of this equipment is implied or assumed.

Table of Contents

Safety Messages.....	V
Introduction.....	1
1.1 Overview	1
1.2 Typical Applications	1
1.3 Main Features of the Analyzer	1
1.4 Model Designations	2
1.5 Front Panel (Operator Interface)	3
1.5.1 Displays	6
1.5.2 Function Keys	6
1.5.3 Data Entry Keys	6
1.5.4 I/O Power Button	7
1.5.5 Access Door	7
1.6 Recognizing Difference Between LCD & VFD	7
1.7 Equipment Interface	7
1.7.1 Electrical Connector Panel	7
1.7.2 Gas Connector Panel	9
Operational Theory.....	11
2.1 Introduction	11
2.2 Micro-Fuel Cell Sensor	11
2.2.1 Principles of Operation	11
2.2.2 Anatomy of a Micro-Fuel Cell	12
2.2.3 Electrochemical Reactions	13
2.2.4 The Effect of Pressure	14
2.2.5 Calibration Characteristics	14
2.3 Sample System	15
2.4 Electronics and Signal Processing	16
Installation.....	19
3.1 Unpacking the Analyzer	19

3.2 Mounting the Analyzer	19
3.3 Electrical Connections	21
3.3.1 Primary Input Power	22
3.3.2 Fuse Installation	22
3.3.3 Analog Outputs	23
3.3.4 Alarm Relays	25
3.3.5 Digital Remote Cal Inputs	26
3.3.6 Range ID Relays	27
3.3.7 Network I/O	27
3.3.8 RS-232 Port	28
3.3.9 Remote Sensor and Solenoid Valves	29
3.4 Installing the Micro-Fuel Cell	30
3.5 Gas Connections	30
3.6 Testing the System	33
Operation	35
4.1 Introduction	35
4.2 Using the Data Entry and Function Buttons	35
4.3 The System Function	37
4.3.1 Tracking Oxygen Readings During Calibration and Alarm Delay	38
4.3.2 Setting up an Auto-Cal	40
4.3.3 Password Protection	41
4.3.3.1 Entering the Password	41
4.3.3.2 Installing or Changing the Password	42
4.3.4 Logout	44
4.3.5 System Self-Diagnostic Test	45
4.3.6 Version Screen	46
4.3.7 Showing Negative Oxygen Readings	46
4.4 The Zero and Span Functions	47
4.4.1 Zero Cal	48
4.4.1.1 Auto Mode Zeroing	48
4.4.1.2 Manual Mode Zeroing	49
4.4.1.3 Cell Failure	50
4.4.2 Span Cal	50

4.4.2.1 Auto Mode Spanning	50
4.4.2.2 Manual Mode Spanning	52
4.4.3 Span Failure	53
4.5 The Alarms Function	53
4.6 The Range Function	56
4.6.1 Setting the Analog Output Ranges	56
4.6.2 Fixed Range Analysis	57
4.7 The Analyze Function	58
4.8 Maintenance Schedule	58
4.9 Sensor Detection	60
4.10 Valve Box Functions	62
4.10.1 Serial#	63
4.10.2 Stream	63
4.10.3 SerMode	64
Maintenance.....	67
5.1 Routine Maintenance	67
5.2 Major Internal Components	67
5.3 Cell Replacement	68
5.3.1 Storing and Handling Replacement Cells	69
5.3.2 When to Replace a Cell	69
5.3.3 Removing the Micro-Fuel Cell	70
5.3.4 Installing a New Micro-Fuel Cell	72
5.3.5 Cell Lifetime	73
5.4 Fuse Replacement	73
5.5 System Self Diagnostic Test	74
5.6 Troubleshooting	75
Appendix.....	77
A-1 Model 3000TB Specifications	77
A-2 Recommended 2-Year Spare Parts List	79
A-3 Drawing List	79
A.5 Application Notes	80
A-6 Material Safety Data Sheet	84

List of Figures

Figure 1-1: Model 3000TB—Outer Door Open—Showing Control Panel	4
Figure 1-2: Model 3000TB—Inner Door Open—Showing Internal Components	5
Figure 1-3: Electrical Connector Panel	8
Figure 1-4: Model 3000TB Gas Connector Panel.....	10
Figure 2-1: Micro-Fuel Cell	12
Figure 2-2: Cross Section of a Micro-Fuel Cell (not to scale)	12
Figure 2-3: Characteristic Input/Output Curve for a Micro-Fuel Cell.....	15
Figure 2-4: Flow Diagram	16
Figure 2-5: Block Diagram of the Model 3000TB Electronics	17
Figure 3-1: Front View of the Model 3000TB (Simplified).....	20
Figure 3-2: Required Front Door Clearance	21
Figure 3-3: Electrical Connector Panel.....	21
Figure 3-4: Primary Input Power Connections.....	22
Figure 3-5: Analog Output Connections	23
Figure 3-6: Types of Relay Contacts	25
Figure 3-7: Remote Sensor Connector Pinouts.....	29
Figure 3-8: Remote Solenoid Return Connector	29
Figure 3-9: FET Series Resistance.....	30
Figure 3-10: Gas Connector Panel.....	32
Figure 5-1: Major Internal Components	68
Figure 5-2: Exploded View of Cell Block and Micro-Fuel Cell.....	71
Figure 5-3: Removing Fuse Cap and Fuse from Holder	73

List of Tables

Table 3-1: Analog Concentration Output—Example.....	24
Table 3-2: Analog Range ID Output—Example.....	24
Table 3-3: RS-232 Signals	28
Table 3-4: Commands via RS-232 Input	28
Table 3-5: Required RS-232 Input.....	29
Table 5-1: Self Test Failure Codes	74

Introduction

1.1 Overview

The Teledyne Analytical Instruments Model 3000TB Trace Oxygen Analyzer is a versatile microprocessor-based instrument for detecting oxygen in a variety of gases. This manual covers the Model 3000TB, trace oxygen, bulkhead-mount, general purpose units only. These instruments are for use in non-hazardous environments only.

1.2 Typical Applications

A few typical applications of the Model 3000TB are:

- Monitoring inert gas blanketing
- Air separation and liquefaction
- Chemical reaction monitoring
- Semiconductor manufacturing
- Petrochemical process control
- Quality assurance
- Gas analysis certification.

1.3 Main Features of the Analyzer

The Model 3000B Trace Oxygen Analyzer is sophisticated yet simple to use. The main features of the analyzer include:

- A 2-line alphanumeric display screen, driven by microprocessor electronics, that continuously prompts and informs the operator.
- High resolution, accurate readings of oxygen content from low ppm levels through 250,000 ppm. Large, bright, meter readout.
- 316 Stainless steel cell block and sample system—all wetted parts.

- Advanced Micro-Fuel Cell for trace analysis. Standard Insta Trace cell has rapid recovery from air to low ppm during initial installation.
- Versatile analysis over a wide range of applications.
- Microprocessor based electronics: 8-bit CMOS microprocessor with 32 kB RAM and 128 kB ROM.
- Three user definable output ranges (from 0-10 ppm through 0.25 % allow best match to users process and equipment.
- Air-calibration range for convenient spanning at 20.9 %.
- Auto Ranging allows analyzer to automatically select the proper preset range for a given measurement. Manual override allows the user to lock onto a specific range of interest.
- Two adjustable concentration alarms and a system failure alarm.
- Extensive self-diagnostic testing, at startup and on demand, with continuous power-supply monitoring.
- RS-232 serial digital port for use with a computer or other digital communication device.
- Analog outputs for concentration and range identification. (0-1 V dc standard, and isolated 4–20 mA dc optional.)

1.4 Model Designations

3000TB:	Standard model.
3000TB-C:	In addition to all standard features, this model also has separate ports for zero and span gases, and built-in control valves. The internal valves are entirely under the control of the 3000TB electronics, to automatically switch between gases in synchronization with the analyzer's operations.

1.5 Front Panel (Operator Interface)

Figure 1-1 is an illustration of the front of the Model 3000TB Oxygen

Analyzer with the outer door open showing the control panel (which is also the inner door).

All displays on the standard 3000TB are visible from outside the housing. The instrument has a digital meter and an alphanumeric display, which are viewed through a glass viewing window in the front door of the main housing, and a sample flowmeter on the gas control panel attached to the main housing. They give the operator constant feedback from the instrument.

The operator controls are pushbutton membrane switches located behind the front door of the main housing. All of them are reached by swinging open the outer door of the enclosure. They are described briefly here and in greater detail in chapter 4.

Figure 1-2 shows the 3000TB with the outer door and inner door both open. The inner door is opened for access to the electrical connections and to the cell block which houses the Micro-Fuel Cell. Door mounted components are shown in chapter 5.

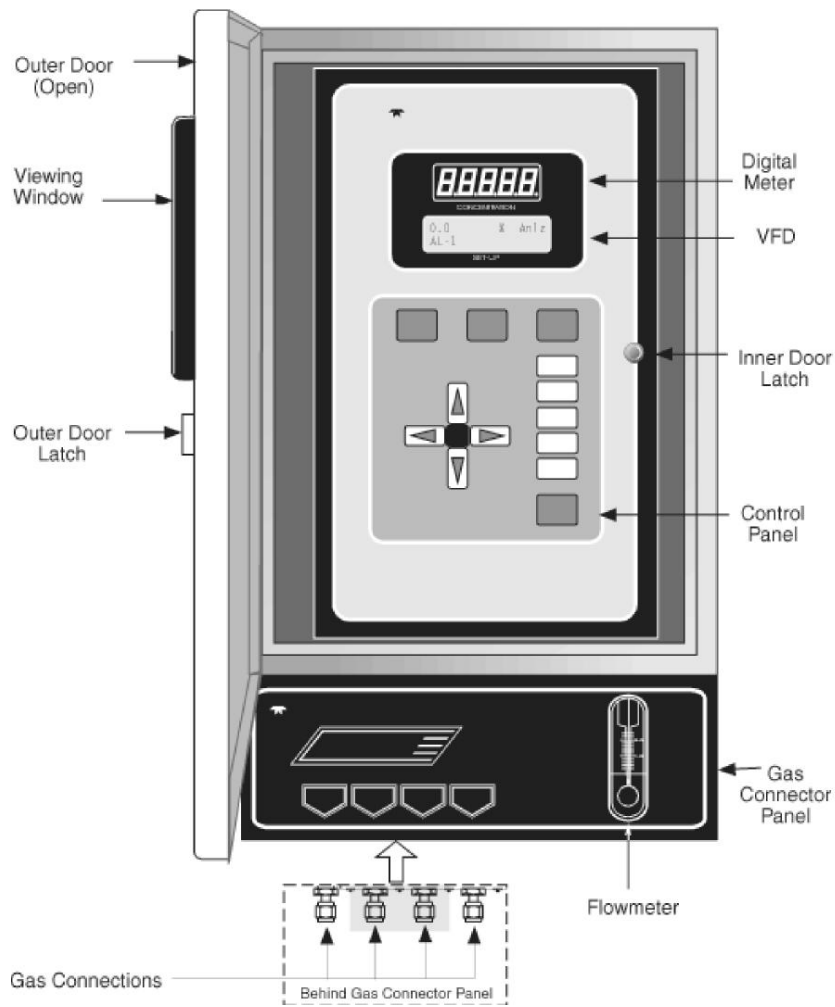

Figure 1-1: Model 3000TB—Outer Door Open—Showing Control Panel

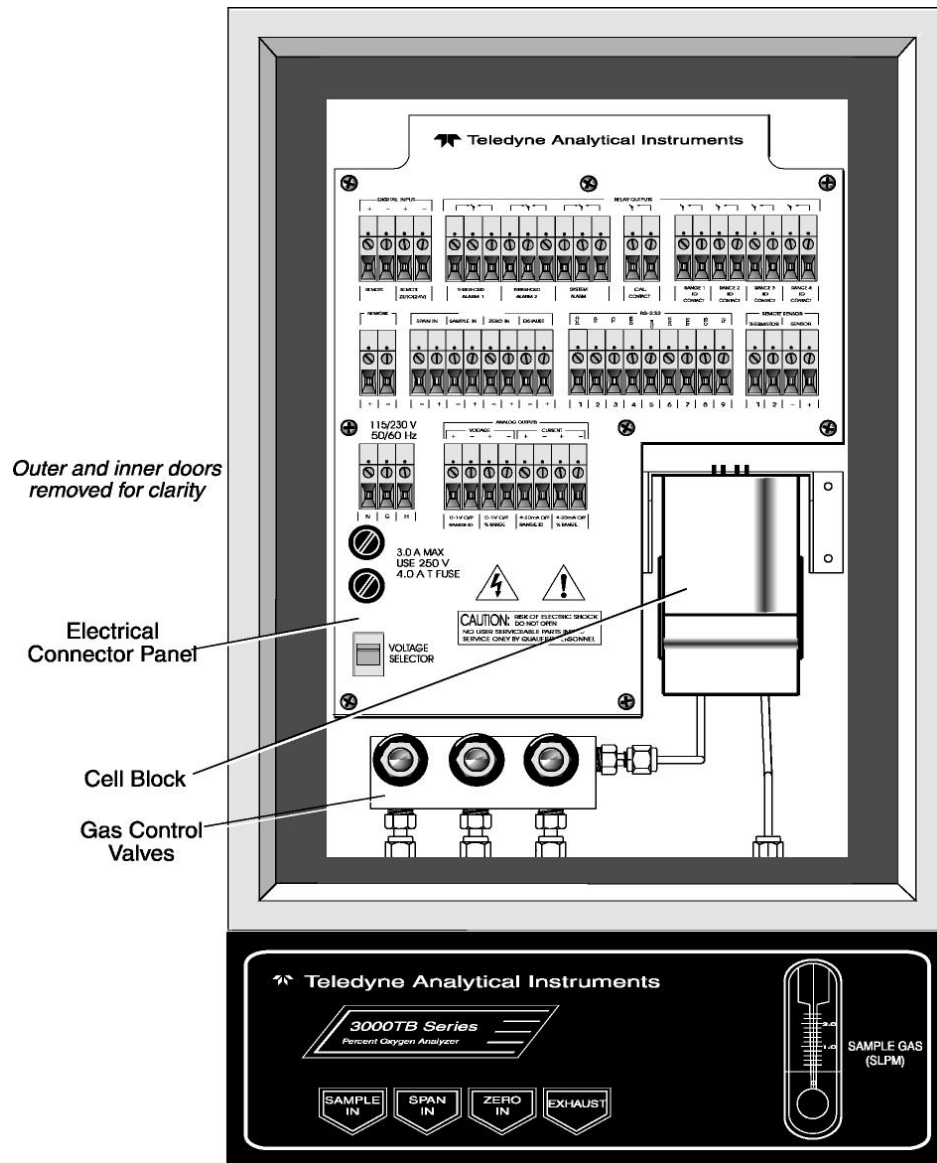

Figure 1-2: Model 3000TB—Inner Door Open—Showing Internal Components

1.5.1 Displays

Digital Meter Display: The meter display is a LED device that produces large, bright, 7-segment numbers that are legible in any lighting environment. It produces a continuous readout from 0-9999 ppm and from 125 %. It is accurate across all ranges without the discontinuity of analog range switching.

Alphanumeric Interface Screen: The backlit VFD screen is an easy-to-use interface from operator to analyzer. It displays values, options, and messages that give the operator immediate feedback.

Flowmeter: Monitors the flow of gas past the sensor. Readout is 0.2 to 2.4 standard liters per minute (SLPM).

1.5.2 Function Keys

Six touch-sensitive membrane switches are used to change the specific function performed by the analyzer:

- **Analyze** Perform analysis for oxygen content of a sample gas.
- **System** Perform system-related tasks (described in detail in chapter 4, *Operation*).
- **Span** Span calibrate the analyzer.
- **Zero** Zero calibrate the analyzer.
- **Alarms** Set the alarm setpoints and attributes.
- **Range** Set up the 3 user definable ranges for the instrument.

1.5.3 Data Entry Keys

Six touch-sensitive membrane switches are used to input data to the instrument via the alphanumeric VFD display:

- **Left & Right Arrows** Select between functions currently displayed on the VFD screen.
- **Up & Down Arrows** Increment or decrement values of functions currently displayed.
- **Enter** Moves VFD display on to the next screen in a series. If none remains, returns to the *Analyze* screen.

Escape Moves VFD display back to the previous screen in a series. If none remains, returns to the *Analyze* screen.

1.5.4 I/O Power Button

The red I/O button switches the instrument power between *I* (ON) and *O* (a Keep-Alive state). In the *O* state, the instrument's circuitry is operating, but there are no displays or outputs.

CAUTION: THE POWER CABLE MUST BE UNPLUGGED TO FULLY DISCONNECT POWER FROM THE INSTRUMENT. WHEN CHASSIS IS EXPOSED OR WHEN ACCESS DOOR IS OPEN AND POWER CABLE IS CONNECTED, USE EXTRA CARE TO AVOID CONTACT WITH LIVE ELECTRICAL CIRCUITS.



1.5.5 Access Door

To access the electrical connector panel, or the cell block, the control panel doubles as an inner door that can be unlatched and swung open (after unlatching and swinging open the outer access door). See Figure 1-2. unfastening rear panel screws and sliding the unit out of the case.

1.6 Recognizing Difference Between LCD & VFD

LCD has *GREEN* background with *BLACK* characters. VFD has *DARK* background with *GREEN* characters. In the case of VFD - *NO CONTRAST ADJUSTMENT IS NEEDED*.

1.7 Equipment Interface

1.7.1 Electrical Connector Panel

The electrical connector panel, shown in Figure 1-3, contains the electrical connections for external inputs and outputs. The connectors are described briefly here and in detail in the Installation chapter of this manual.

CAUTION: THE POWER CABLE MUST BE DISCONNECTED TO FULLY REMOVE POWER FROM THE INSTRUMENT.



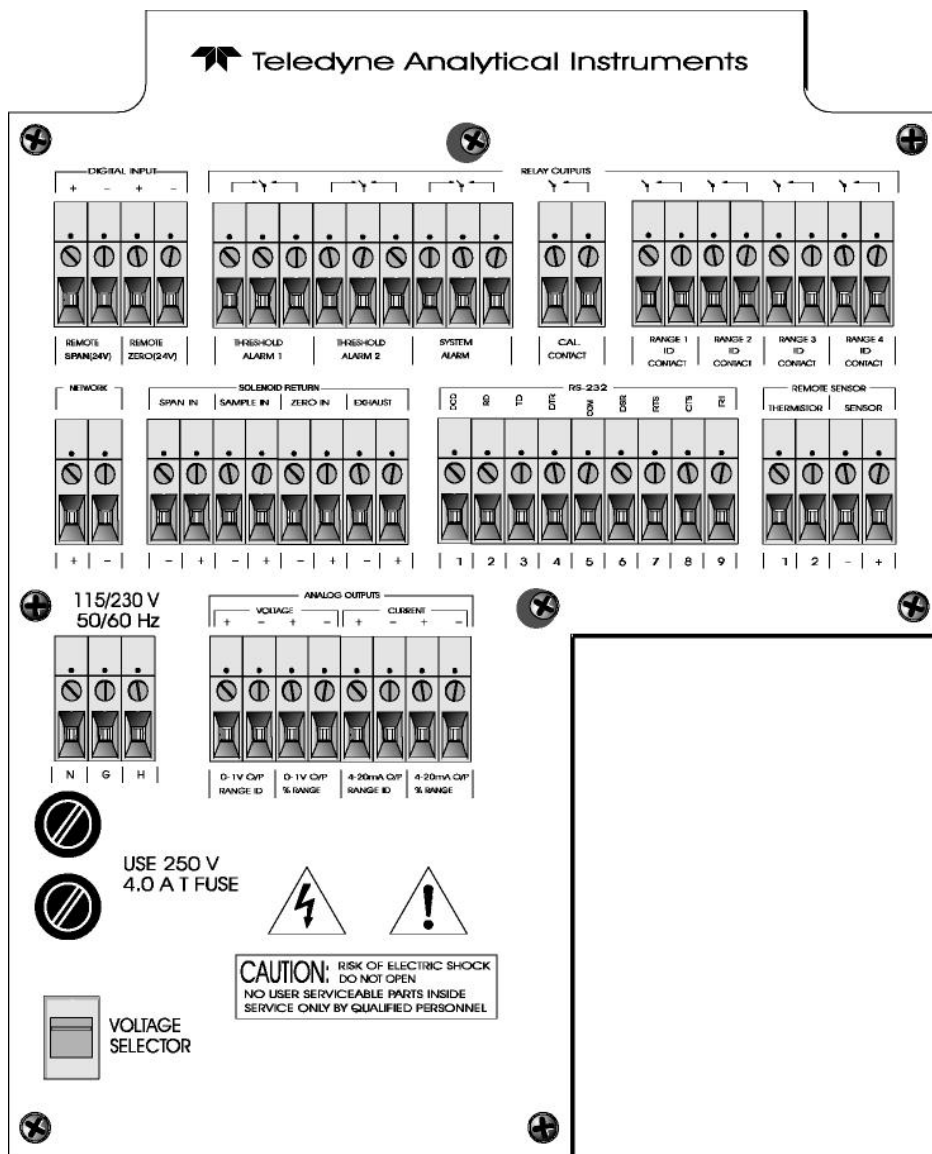

Figure 1-3: Electrical Connector Panel

Electrical Connections: The electrical connections on the electrical connector panel are described briefly here, and in more detail in chapter 3 *Installation*.

- **Power Connection** 115 or 230 VDC 50 or 60 Hz.
- **Analog Outputs** 0-1 V dc concentration plus 0-1 V dc range ID, and isolated 4-20 mA dc plus 4-20 mA dc range ID.
- **Alarm Connections** 2 concentration alarms and 1 system alarm.
- **RS-232 Port** Serial digital concentration signal output and control input.
- **Remote Valves** Used for controlling external solenoid valves if desired.
- **Remote Sensor** Used for external sensor and thermocouple, if desired.
- **Remote Span/Zero** Digital inputs allow external control of analyzer calibration.
- **Calibration Contact** To notify external equipment that instrument is being calibrated and readings are not monitoring sample.
- **Range ID Contacts** Four separate, dedicated, range relay contacts. Low, Medium, High, Cal.
- **Network I/O** Serial digital communications for local network access. For future expansion. Not implemented at this printing.

1.7.2 Gas Connector Panel

The gas connector panel, shown in Figure 1-4, contains the gas connections for external inlets and outlets. Those that are optional are shown shaded in the figure. The connectors are described briefly here and in detail in the Installation chapter of this manual.

- **Gas Inlet and Outlet** One inlet (must be externally valved) and one exhaust out.

Optional:

- **Calibration Gas Ports** Separate fittings for zero, span and sample gas input, plus internal valves for automatically switching the gases in sync with the 3000TB electronics.

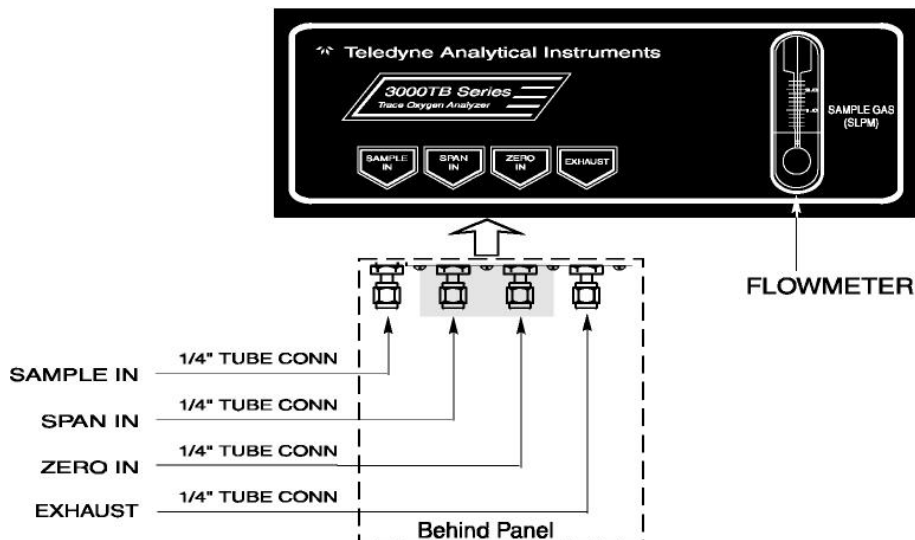

Figure 1-4: Model 3000TB Gas Connector Panel

Note: If you require highly accurate Auto-Cal timing, use external Auto-Cal control where possible. The internal clock in the Model 3000TB is accurate to 2-3 %. Accordingly, internally scheduled calibrations can vary 2-3 % per day.

Operational Theory

2.1 Introduction

The analyzer is composed of three subsystems:

1. Micro-Fuel Cell Sensor
2. Sample System
3. Electronic Signal Processing, Display and Control

The sample system is designed to accept the sample gas and transport it through the analyzer without contaminating or altering the sample prior to analysis. The Micro-Fuel Cell is an electrochemical galvanic device that translates the amount of oxygen present in the sample into an electrical current. The electronic signal processing, display and control subsystem simplifies operation of the analyzer and accurately processes the sampled data. The microprocessor controls all signal processing, input/output and display functions for the analyzer.

2.2 Micro-Fuel Cell Sensor

2.2.1 Principles of Operation

The oxygen sensor used in the Model 3000T series is a Micro-Fuel Cell designed and manufactured by Analytical Instruments. It is a sealed plastic disposable electrochemical transducer.

The active components of the Micro-Fuel Cell are a cathode, an anode, and the 15% aqueous KOH electrolyte in which they are immersed. The cell converts the energy from a chemical reaction into an electrical current in an external electrical circuit. Its action is similar to that of a battery.

There is, however, an important difference in the operation of a battery as compared to the Micro-Fuel Cell: In the battery, all reactants are stored within the cell, whereas in the Micro-Fuel Cell, one of the reactants (oxygen) comes from outside the device as a constituent of the sample gas being analyzed. The Micro-Fuel Cell is therefore a hybrid between a battery and a true fuel cell. (All of the reactants are stored externally in a true fuel cell.)

2.2.2 Anatomy of a Micro-Fuel Cell

The Micro-Fuel Cell is a cylinder only 1 1/4 inches in diameter and 1 1/4 inches thick. It is made of an extremely inert plastic, which can be placed confidently in practically any environment or sample stream. It is effectively sealed, although one end is permeable to oxygen in the sample gas. The other end of the cell is a contact plate consisting of two concentric foil rings. The rings mate with spring-loaded contacts in the sensor block assembly and provide the electrical connection to the rest of the analyzer. Figure 2-1 illustrates the external features.

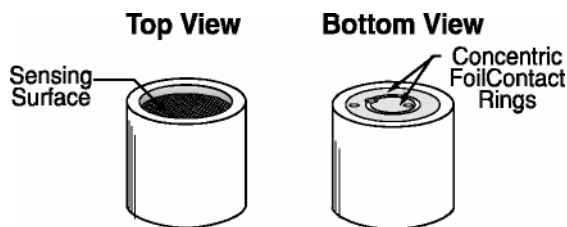

Figure 2-1: Micro-Fuel Cell

Refer to Figure 2-2, *Cross Section of a Micro-Fuel Cell*, which illustrates the following internal description.

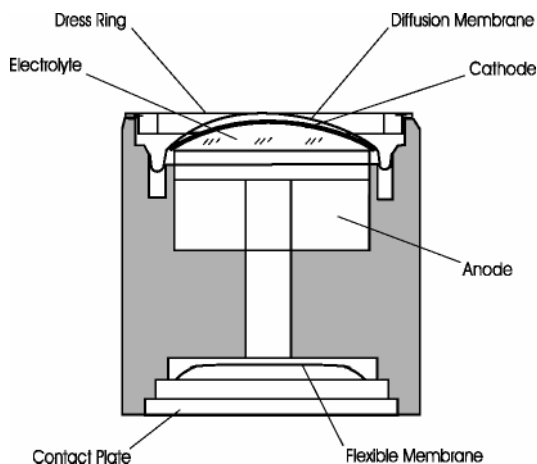

Figure 2-2: Cross Section of a Micro-Fuel Cell (not to scale)

At the top end of the cell is a diffusion membrane of Teflon®, whose thickness is very accurately controlled. Beneath the diffusion membrane lies the oxygen sensing element—the cathode—with a surface area almost 4 cm². The cathode has many perforations to ensure

sufficient wetting of the upper surface with electrolyte, and it is plated with an inert metal.

The anode structure is below the cathode. It is made of lead and has a proprietary design which is meant to maximize the amount of metal available for chemical reaction.

At the rear of the cell, just below the anode structure, is a flexible membrane designed to accommodate the internal volume changes that occur throughout the life of the cell. This flexibility assures that the sensing membrane remains in its proper position, keeping the electrical output constant.

The entire space between the diffusion membrane, above the cathode, and the flexible rear membrane, beneath the anode, is filled with electrolyte. Cathode and anode are submerged in this common pool. They each have a conductor connecting them to one of the external contact rings on the contact plate, which is on the bottom of the cell.

2.2.3 Electrochemical Reactions

The sample gas diffuses through the Teflon membrane. Any oxygen in the sample gas is reduced on the surface of the cathode by the following HALF REACTION:



(Four electrons combine with one oxygen molecule—in the presence of water from the electrolyte—to produce four hydroxyl ions.)

When the oxygen is reduced at the cathode, lead is simultaneously oxidized at the anode by the following HALF REACTION:

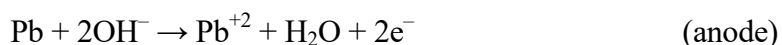

(Two electrons are transferred for each atom of lead that is oxidized. Therefore it takes two of the above anode reactions to balance one cathode reaction and transfer four electrons.)

The electrons released at the surface of the anode flow to the cathode surface when an external electrical path is provided. The current is proportional to the amount of oxygen reaching the cathode. It is measured and used to determine the oxygen concentration in the gas mixture.

The overall reaction for the fuel cell is the SUM of the half reactions above, or:

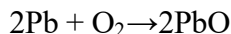

(These reactions will hold as long as no gaseous components capable of oxidizing lead—such as iodine, bromine, chlorine and fluorine—are present in the sample.)

The output of the fuel cell is limited by (1) the amount of oxygen in the cell at the time and (2) the amount of stored anode material.

In the absence of oxygen, no current is generated.

2.2.4 The Effect of Pressure

In order to state the amount of oxygen present in the sample in parts-per-million or a percentage of the gas mixture, it is necessary that the sample diffuse into the cell under constant pressure.

If the total pressure increases, the rate that oxygen reaches the cathode through the diffusing membrane will also increase. The electron transfer, and therefore the external current, will increase, even though the oxygen concentration of the sample has not changed. It is therefore important that the sample pressure at the fuel cell (usually vent pressure) remain relatively constant between calibrations.

2.2.5 Calibration Characteristics

Given that the total pressure of the sample gas on the surface of the Micro-Fuel Cell input is constant, a convenient characteristic of the cell is that the current produced in an external circuit is directly proportional to the rate at which oxygen molecules reach the cathode, and this rate is directly proportional to the concentration of oxygen in the gaseous mixture. In other words it has a linear characteristic curve, as shown in Figure 2-3. Measuring circuits do not have to compensate for nonlinearities.

In addition, since there is zero output in the absence oxygen, the characteristic curve has close to an absolute zero (within ± 1 ppm oxygen). In practical application, zeroing may still be used to compensate for the combined zero offsets of the cell and the electronics. (The electronics is zeroed automatically when the instrument power is turned on.)

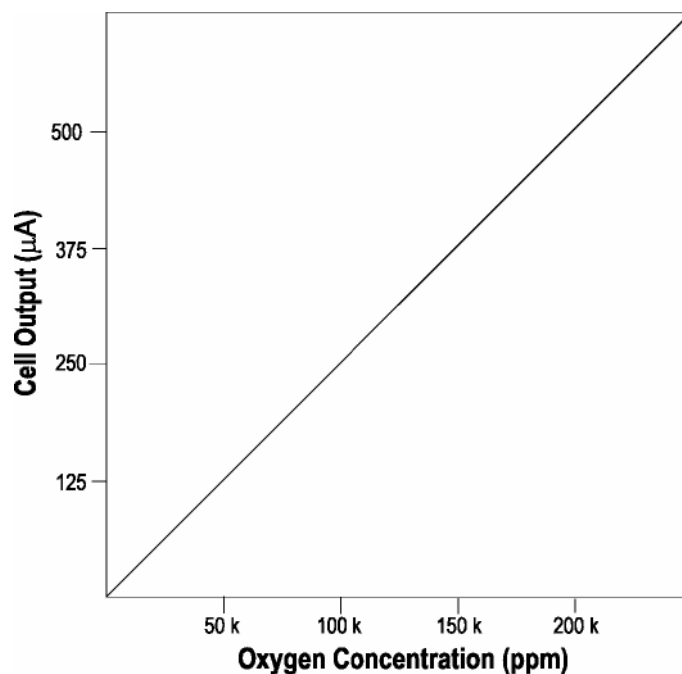

Figure 2-3: Characteristic Input/Output Curve for a Micro-Fuel Cell

2.3 Sample System

The sample system delivers gases to the Micro-Fuel Cell sensor from the analyzer rear panel inlet. Depending on the mode of operation either sample or calibration gas is delivered.

The Model 3000TB sample system is designed and fabricated to ensure that the oxygen concentration of the gas is not altered as it travels through the sample system. The sample encounters almost no dead space. This minimizes residual gas pockets that can interfere with trace analysis.

The sample system for the standard instrument incorporates 1/4 inch tube fittings for sample inlet and outlet connections at the rear panel. For metric system installations, 6 mm adapters are supplied with each instrument to be used if needed. The sample or calibration gas flows through the system is monitored by a flowmeter downstream from the cell.

Figure 2-4 is the flow diagram for the sampling system. In the standard instrument, calibration gases (zero and span) can be connected directly to the Sample In port by teeing to the port with appropriate valves. The shaded portion of the diagram shows the components added when the -C option is ordered. The valves, when supplied, are installed inside the 3000TB enclosure and are regulated by the instrument's internal electronics.

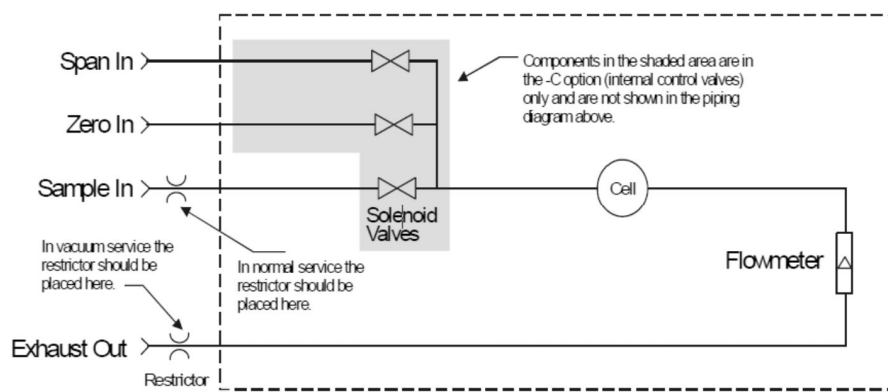

Figure 2-4: Flow Diagram

2.4 Electronics and Signal Processing

The signal processing and display electronics PCBs are mounted on the back of the inner door. See Major Internal Components in chapter 5, for illustration. The power supply module is mounted underneath the bottom end of the Electrical Connector Panel.

The Model 3000TB Trace Oxygen Analyzer uses an 8031 microcontroller with 32 kB of RAM and 128 kB of ROM to control all signal processing, input/output, and display functions for the analyzer. System power is supplied from a universal power supply module designed to be compatible with any international power source. Figure 2-5 is a simplified block diagram of the Analyzer electronics.

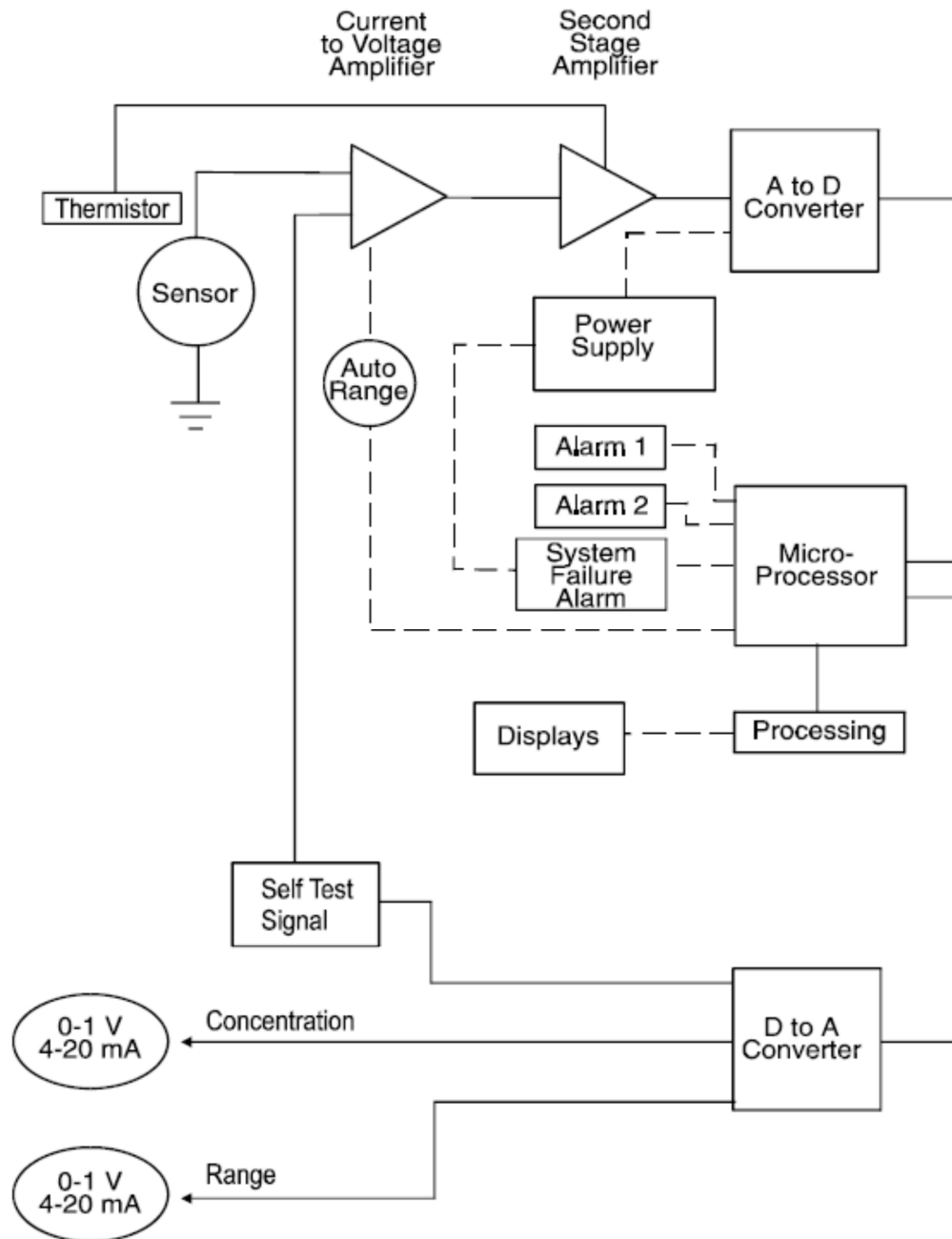

Figure 2-5: Block Diagram of the Model 3000TB Electronics

In the presence of oxygen the cell generates a current. A current to voltage amplifier converts this current to a voltage, which is amplified in the second stage amplifier.

The second stage amplifier also supplies temperature compensation for the oxygen sensor output. This amplifier circuit incorporates a thermistor, which is physically located in the cell block. The thermistor is a temperature dependent resistance that changes the gain of the amplifier in proportion to the temperature changes in the block. This change is inversely proportional to the change in the cell output due to the same temperature changes. The result is a signal that is temperature independent. The output from the second stage amplifier is sent to an 18 bit analog to digital converter controlled by the microprocessor.

The digital concentration signal along with input from the control panel is processed by the microprocessor, and appropriate control signals are directed to the display, alarms and communications port. The same digital information is also sent to a 12 bit digital to analog converter that produces the 4-20 mA DC and the 0-1 VDC analog concentration signal outputs, and the analog range ID outputs.

Signals from the power supply are also monitored, and through the microprocessor, the system failure alarm is activated if a malfunction is detected.

Installation

Installation of the Model 3000TB Analyzer includes:

1. Unpacking
2. Mounting
3. Gas connections
4. Electrical connections
5. Installing the Micro-Fuel Cell
6. Testing the system.

3.1 Unpacking the Analyzer

Although the analyzer is shipped complete, certain parts, such as fuses and sensors, are wrapped separately to be installed on site as part of the installation. Carefully unpack the analyzer and inspect it for damage. Immediately report any damage or shortages to the shipping agent.

3.2 Mounting the Analyzer

The Model 3000TB is designed for bulkhead mounting in non-hazardous environments. There are four mounting lugs—one in each corner of the enclosure. The outline drawing, at the back of this manual, gives the mounting hole size and spacing. The drawing also contains the overall dimensions. Do not forget to allow an extra 1 3/8" for the hinges.

Be sure to allow enough space in front of the enclosure to swing the door open—a 11 3/4" radius, as shown in Figure 3-2.

All electrical connections are made via cables which enter the housing through ports in its side. No conduit fittings are supplied. The installer must provide two 3/4" NPT and two 1" NPT adapters and the appropriate sealing conduit.

For gas connections, the unit is supplied with 1/8" tube fittings, and three millimeter adapters are supplied for metric system installations.

Figure 3-1 shows the Mode31 3000TB in front view with the front door closed.

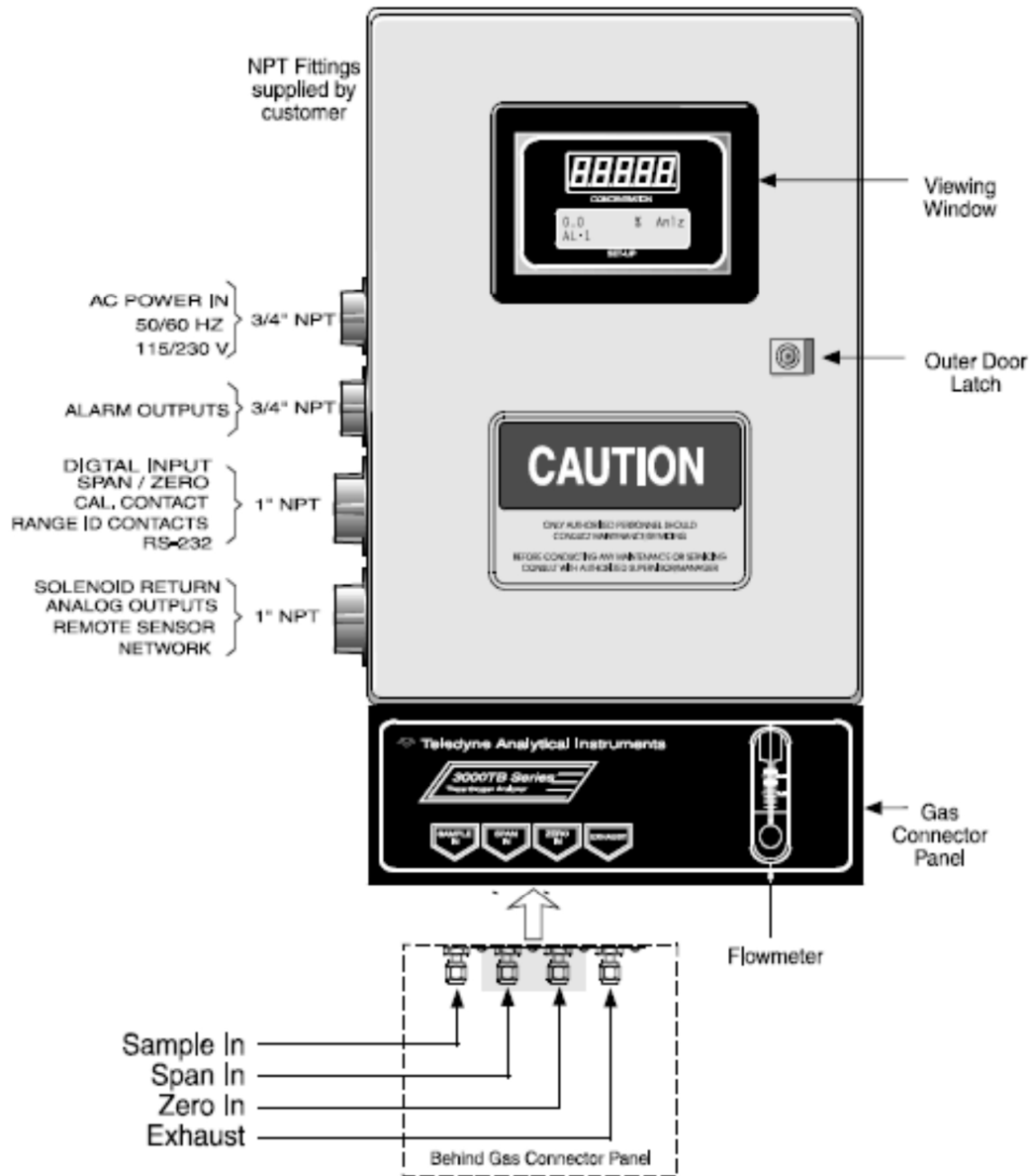

Figure 3-1: Front View of the Model 3000TB (Simplified)

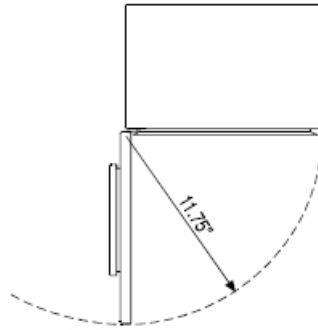

Figure 3-2: Required Front Door Clearance

3.3 Electrical Connections

Figure 3-3 shows the Model 3000TB Electrical Connector Panel. There are terminal blocks for connecting power, communications, and both digital and analog concentration outputs.

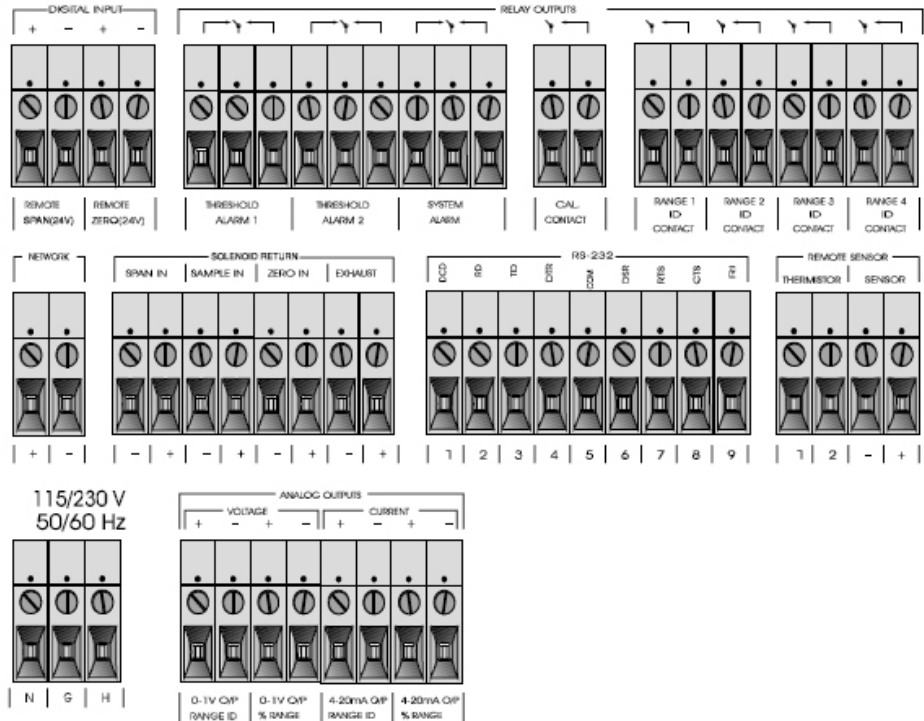

Figure 3-3: Electrical Connector Panel

For safe connections, ensure that no uninsulated wire extends outside of the connectors they are attached to. Stripped wire ends must insert completely into terminal blocks. No uninsulated wiring should be able to come in contact with fingers, tools or clothing during normal operation.

3.3.1 Primary Input Power

The universal power supply requires a 115 or 230 VAC, 50 or 60 Hz power source. The actual input voltage used must show in the window of the VOLTAGE SELECTOR switch **before** the power source is connected. See Figure 3-4 for detailed connections.

DANGER: *Power is applied to the instrument's circuitry as long as the instrument is connected to the power source. The Standby Function switches power on or off to the displays and outputs only.*

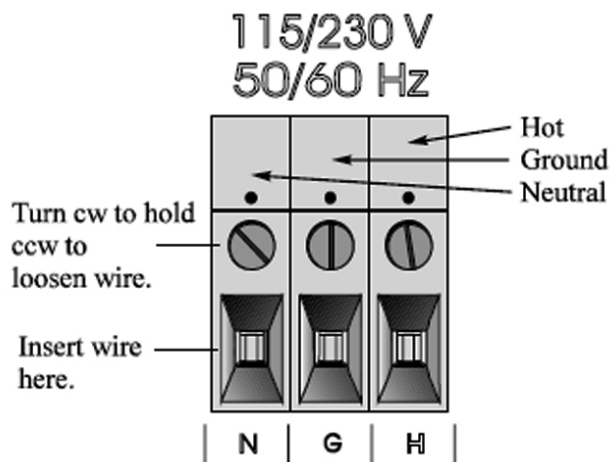

Figure 3-4: Primary Input Power Connections

3.3.2 Fuse Installation

The fuse holders accept 5 x 20 mm, 1.6 A, T type (slow blow) fuses. Fuses are not installed at the factory. Be sure to install the proper fuse as part of the installation. (See *Fuse Replacement* in chapter 5, *maintenance*.)

3.3.3 Analog Outputs

There are eight DC output signal connectors on the ANALOG OUTPUTS connector block. There are two connectors per output with the polarity noted. See Figure 3-5.

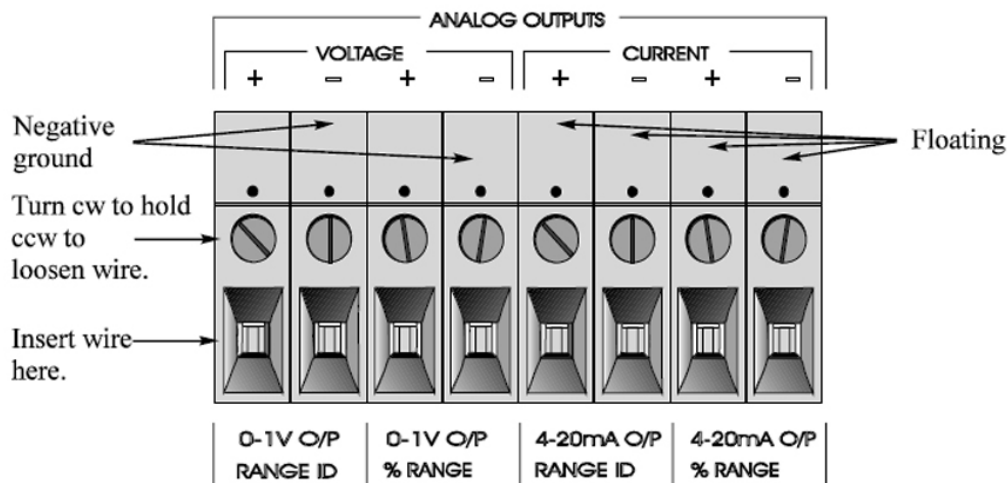

Figure 3-5: Analog Output Connections

The outputs are:

- 0–1 V dc % of Range: Voltage rises linearly with increasing oxygen, from 0 V at 0 ppm to 1 V at full scale ppm. (Full scale = 100% of programmable range.)
- 0–1 V dc Range ID:
 - 0.25 V = Low Range
 - 0.5 V = Medium Range
 - 0.75 V = High Range
 - 1 V = Air Cal Range
- 4–20 mA dc % Range: Current increases linearly with increasing oxygen, from 4 mA at 0 ppm to 20 mA at full scale ppm. (Full scale = 100% of programmable range.)
- 4–20 mA dc Range ID:
 - 8 mA = Low Range
 - 12 mA = Medium Range
 - 16 mA = High Range
 - 20 mA = Air Cal Range

Examples:

The analog output signal has a voltage which depends on the oxygen concentration AND the currently activated analysis range. To relate the signal output to the actual concentration, it is necessary to know what range the instrument is currently on, especially when the analyzer is in the autoranging mode.

The signal output for concentration is linear over the currently selected analysis range. For example, if the analyzer is set on a range that was defined as 0–100 ppm O₂, then the output would be as shown in Table 3-1.

Table 3-1: Analog Concentration Output—Example

ppm O ₂	Voltage Signal Output (V dc)	Current Signal Output (mA dc)
0	0.0	4.0
10	0.1	5.6
20	0.2	7.2
30	0.3	8.8
40	0.4	10.4
50	0.5	12.0
60	0.6	13.6
70	0.7	15.2
80	0.8	16.8
90	0.9	18.4
100	1.0	20.0

To provide an indication of the range, a second pair of analog output terminals are used. They generate a steady preset voltage (or current when using the current outputs) to represent a particular range. Table 3-2 gives the range ID output for each analysis range.

Table 3-2: Analog Range ID Output—Example

Range	Voltage (V)	Current (mA)
LO	0.25	8
MED	0.50	12
HI	0.75	16
CAL (0-25%)	1.00	20

3.3.4 Alarm Relays

There are three alarm-circuit connectors on the alarm relays block (under RELAY OUTPUTS) for making connections to internal alarm relay contacts. Each provides a set of Form C contacts for each type of alarm. Each has both normally open and normally closed contact connections. The contact connections are indicated by diagrams on the connector panel. They are capable of switching up to 3 amperes at 250 V ac into a resistive load. See Figure 3-6.

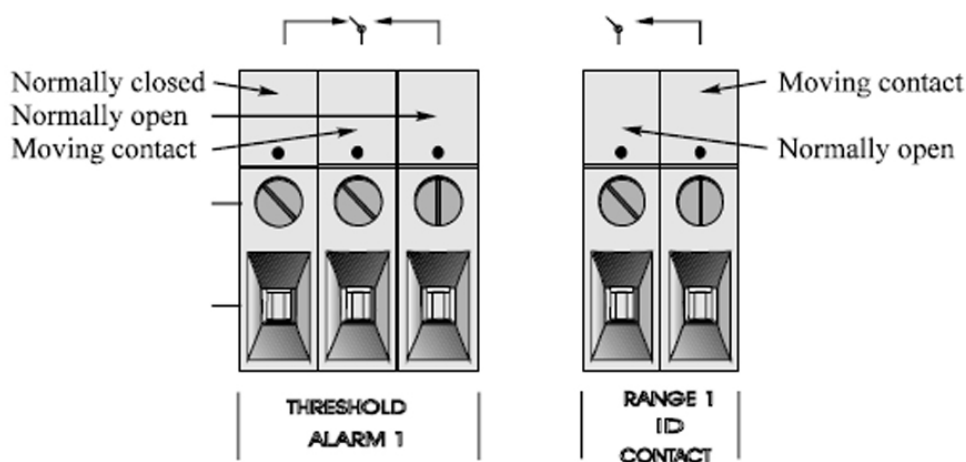



Figure 3-6: Types of Relay Contacts

- **Threshold Alarm 1:**
 - Can be configured as high (actuates when concentration is above threshold), or low (actuates when concentration is below threshold).
 - Can be configured as failsafe or non-failsafe.
 - Can be configured as latching or non-latching.
 - Can be configured out (defeated).
- **Threshold Alarm 2:**
 - Can be configured as high (actuates when concentration is above threshold), or low (actuates when concentration is below threshold).
 - Can be configured as failsafe or non-failsafe.
 - Can be configured as latching or non-latching.
 - Can be configured out (defeated).

- **System Alarm:**
 - Actuates when DC power supplied to circuits is unacceptable in one or more parameters. Permanently configured as failsafe and latching. Cannot be defeated. Actuates if self test fails.
 - Reset by pressing  button to remove power. Then press  again and any other button EXCEPT *System* to resume.

Further detail can be found in chapter 4, section 4-5.

3.3.5 Digital Remote Cal Inputs

Remote Zero and Span Inputs: The REMOTE SPAN and REMOTE ZERO inputs are on the DIGITAL INPUT terminal block. They accept 0 V (off) or 24 VDC (on) inputs for remote control of calibration. (See *Remote Calibration Protocol* below.)

Zero: Floating input. 5 to 24 V input across the + and – pins puts the analyzer into the Zero mode. Either side may be grounded at the source of the signal. 0 to 1 volt across the terminals allows Zero mode to terminate when done. A synchronous signal must open and close the external zero valve appropriately. See section 3.3.9 *Remote Sensor and Solenoid Valves*. (With the –C option internal valves operate synchronously.)

Span: Floating input. 5 to 24 V input across the + and – pins puts the analyzer into the Span mode. Either side may be grounded at the source of the signal. 0 to 1 volt across the terminals allows Span mode to terminate when done. A synchronous signal must open and close external span valve appropriately. See section 3.3.9 *Remote Sensor and Solenoid Valves*. (With the –C option internal valves operate synchronously.)

Cal Contact: This relay contact is closed while analyzer is spanning and/or zeroing. (See *Remote Calibration Protocol* below.)

Remote Calibration Protocol: To properly time the Digital Remote Cal Inputs to the Model 3000TB Analyzer, the customer's controller must monitor the Cal Relay Contact.

When the contact is OPEN, the analyzer is analyzing, the Remote Cal Inputs are being polled, and a zero or span command can be sent.

When the contact is CLOSED, the analyzer is already calibrating. It will ignore your request to calibrate, and it will not remember that request.

Once a zero or span command is sent, and acknowledged (contact closes), release it. If the command is continued until after the zero or span is complete, the calibration will repeat and the Cal Relay Contact (CRC) will close again.

For example:

1. Test the CRC. When the CRC is open, Send a zero command until the CRC closes (The CRC will quickly close.)
2. When the CRC closes, remove the zero command.
3. When CRC opens again, send a span command until the CRC closes. (The CRC will quickly close.)
4. When the CRC closes, remove the span command.

When CRC opens again, zero and span are done, and the sample is being analyzed.

Note: The remote probe connections (described below) provides signals to ensure that the zero and span gas valves will be controlled synchronously. If you have the –C Internal valve option—which includes additional zero and span gas inputs—the 3000TB automatically regulates the zero, span and sample gas flow.

3.3.6 Range ID Relays

Four dedicated Range ID relay contacts. The first three ranges are assigned to relays in ascending order—Low range is assigned to Range 1 ID, Medium range is assigned to Range 2 ID, and High range is assigned to Range 3 ID. The fourth range is reserved for the Air Cal Range (25%).

3.3.7 Network I/O

A serial digital input/output for local network protocol. At this printing, this port is not yet functional. It is to be used in future versions of the instrument.

3.3.8 RS-232 Port

The digital signal output is a standard RS-232 serial communications port used to connect the analyzer to a computer, terminal, or other digital device. The pinouts are listed in Table 3-3.

Table 3-3: RS-232 Signals

RS-232 Sig	RS-232 Pin	Purpose
DCD	1	Data Carrier Detect
RD	2	Received Data
TD	3	Transmitted Data
DTR	4	Data Terminal Ready
COM	5	Common
DSR	6	Data Set Ready
RTS	7	Request to Send
CTS	8	Clear to Send
RI	9	Ring Indicator

The data sent is status information, in digital form, updated every two seconds. Status is reported in the following order:

- The concentration in ppm or percent
- The range in use (HI, MED, LO)
- The span of the range (0-100 ppm, etc)
- Which alarms—if any—are disabled (AL-x DISABLED)
- Which alarms—if any—are tripped (AL-x ON).

Three input functions using RS-232 have been implemented to date. They are described in Table 3-4.

Table 3-4: Commands via RS-232 Input

Command	Description
as <enter>	Immediately starts an autospan.
az <enter>	Immediately starts an autozero.
st <enter>	Toggling input. Stops/Starts any status message output from the RS-232, until st <enter> is sent again.

The RS-232 protocol allows some flexibility in its implementation. Table 3-6 lists certain RS-232 values that are required by the 3000TB implementation.

Table 3-5: Required RS-232 Input

Parameter	Setting
Baud	2400
Byte	8 bits
Parity	none
Stop Bits	1
Message Interval	2 seconds.

3.3.9 Remote Sensor and Solenoid Valves

The 3000TB is a single-chassis instrument, which has its own sensor and, in the –C option, its own gas-control solenoid valves. However, The REMOTE SENSOR and SOLENOID RETURN connectors are provided for use with a remote sensor and/or gas flow control valves, if desired. See Figures 3-7 and 3-8.

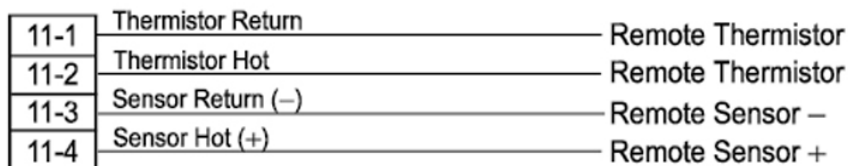

Figure 3-7: Remote Sensor Connector Pinouts

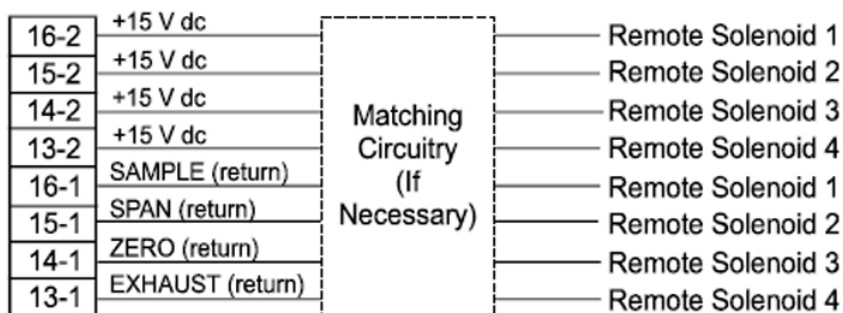

Figure 3-8: Remote Solenoid Return Connector

The voltage from these outputs is nominally 0 V for the OFF and 15 V dc for the ON conditions. The maximum combined current that can be pulled from these output lines is 100 mA. (If two lines are ON at the

same time, each must be limited to 50 mA, etc.) If more current and/or a different voltage is required, use a relay, power amplifier, or other matching circuitry to provide the actual driving current.

In addition, each individual line has a series FET with a nominal ON resistance of 5 ohms (9 ohms worst case). This could limit the obtainable voltage, depending on the load impedance applied. See Figure 3-9.

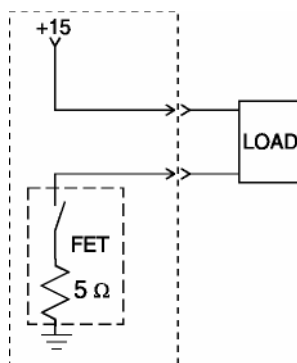

Figure 3-9: FET Series Resistance

3.4 Installing the Micro-Fuel Cell

The Micro-Fuel Cell is not installed in the cell block when the instrument is shipped. Install it before the analyzer is placed in service.

Once it is expended, or if the cell is exposed to air for too long, the Micro-Fuel Cell will need to be replaced. The cell could also require replacement if the instrument has been idle for too long.

When the Micro-Fuel Cell needs to be installed or replaced, follow the procedures in Chapter 5, *Maintenance*, for removing and installing cells.

3.5 Gas Connections

Before using this instrument, it should be determined if the unit will be used for pressurized service or vacuum service and low pressure applications. Inspect the restrictor kit that came with the unit. The kit

consists of two restrictors and a union for 1/4" diameter tubing. Notice that the two 1-3/4" long, 1/4" diameter tubing are restrictors. It has an open end and a closed end with a small circular orifice. The restrictor without the blue sticker is for low pressure and vacuum service. For high pressure applications (5-50psig), use the restrictor that has a blue sticker on the body.

For pressurized service use the restrictor **with** the blue dot and union from the restrictor kit and attach it to the Sample In port. The small circular orifice should face away from the back of the unit (against the direction of gas flow).

For positive pressures less than 5 psig use the low-pressure restrictor **without** the blue dot in the **Sample-in** line in the same manner.

For vacuum service (5-10 in Hg), use the restrictor **without** the blue dot sticker and union but attach it to the **Exhaust Out** port. The small circular orifice should face toward the back of the unit (against the direction of gas flow).

Remove the blue sticker from the restrictor before using.

Warning: *Operating the unit without restrictors can cause damage to the micro-fuel cell.*



Figure 3-10 is an illustration of the Gas Connector Panel. The unit is manufactured with 1/4 inch tube fittings, and 6 mm adapters are supplied for metric system installations. For a safe connection:

1. Insert the tube into the tube fitting, and finger-tighten the nut until the tubing cannot be rotated freely, by hand, in the fitting. (This may require an additional 1/8 turn beyond finger-tight.)
2. Hold the fitting body steady with a backup wrench, and with another wrench rotate the nut another 1-1/4 turns.

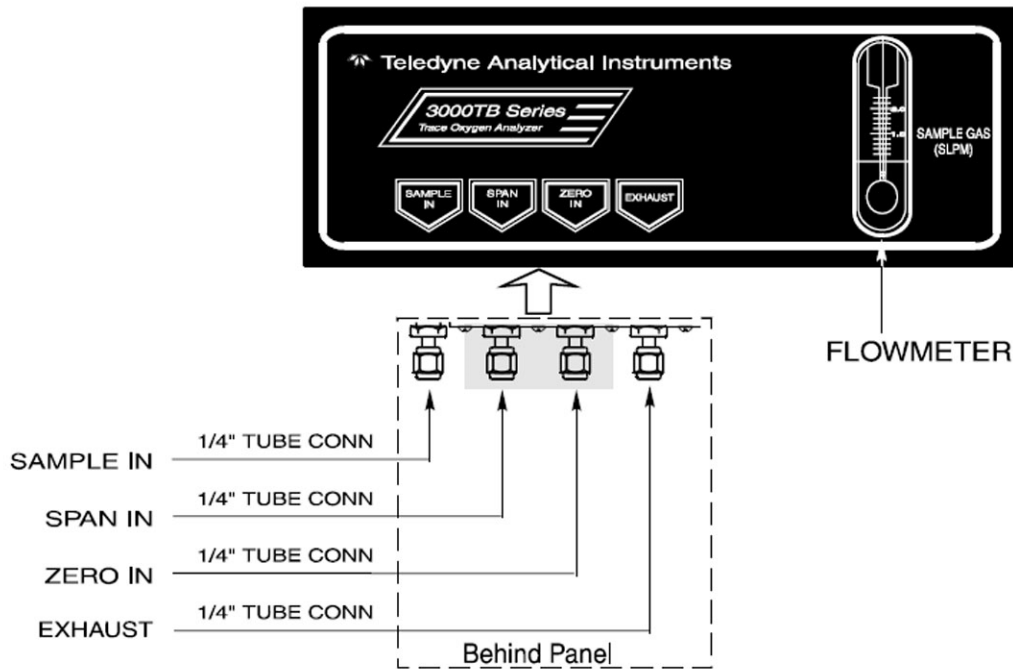

Figure 3-10: Gas Connector Panel

SAMPLE IN:

In the standard model, gas connections are made at the SAMPLE IN and EXHAUST OUT connections. Calibration gases must be tee'd into the Sample inlet with appropriate valves.

The gas pressure in should be reasonably regulated. Pressures between 3 and 40 psig are acceptable as long as the pressure, once established, will keep the front panel flowmeter reading in an acceptable range (0.1 to 2.4 SLPM). Exact figures will depend on your process.

If greater flow is required for improved response time, install a bypass in the sampling system upstream of the analyzer input.

Note: If the unit is for vacuum service, the above numbers apply instead to the vacuum at the EXHAUST OUT connector, described below, with minus signs before the pressure readings.

ZERO IN and SPAN IN:

These are additional ports for inputting span gas and zero gas. There are electrically operated valves inside for automatic switching

between sample and calibration gases. These valves are completely under control of the 3000TB Electronics. They can be externally controlled only indirectly through the Remote Cal Inputs, described below.

Pressure, flow, and safety considerations are the same as prescribed for the SAMPLE IN inlet, above.

EXHAUST OUT:

Exhaust connections must be consistent with the hazard level of the constituent gases. Check Local, State, and Federal laws, and ensure that the exhaust stream vents to an appropriately controlled area if required.

Note: If the unit is for vacuum service, see Sample In, above, for gas pressure/flow considerations.

3.6 Testing the System

Before plugging the instrument into the power source:

- Check the integrity and accuracy of the gas connections. Make sure there are no leaks.
- Check the integrity and accuracy of the electrical connections. Make sure there are no exposed conductors
- Verify that the restriction device has been properly installed (see section 3.3.1).
- Check that the sample pressure is between 3 and 40 psig, according to the requirements of your process.
- Check that the voltage selector switch on the Electrical Connector Panel is in the appropriate position for your power source.

Power up the system, and test it by repeating the Self-Diagnostic Test as described in Chapter 4, Section 4.3.5.

[BLANK PAGE]

Operation

4.1 Introduction

Once the analyzer has been installed, it can be configured for your application. To do this you will:

- Set system parameters:
 - Establish a security password, if desired, requiring Operator to log in.
 - Establish and start an automatic calibration cycle, if desired.
- Calibrate the instrument.
- Define the three user selectable analysis ranges. Then choose autoranging or select a fixed range of analysis, as required.
- Set alarm setpoints, and modes of alarm operation (latching, failsafe, etc).

Before you configure your 3000TB these default values are in effect:

Ranges: LO = 100 ppm, MED = 1000 ppm, HI = 10,000 ppm.

Auto Ranging: ON

Alarm Relays: Defeated, 1000 ppm, HI, Not failsafe, Not latching.

Zero: Auto, every 0 days at 0 hours.

Span: Auto, at 000008.00 ppm, every 0 days at 0 hours.

If you choose not to use password protection, the default password is automatically displayed on the password screen when you start up, and you simply press *Enter* for access to all functions of the analyzer.

4.2 Using the Data Entry and Function Buttons

Data Entry Buttons: The ◀▶ arrow buttons select options from the menu currently being displayed on the VFD screen. The selected option blinks.

When the selected option includes a modifiable item, the ▲/▼ arrow buttons can be used to increment or decrement that modifiable item.

The *Enter* button is used to accept any new entries on the VFD screen. The *Escape* button is used to abort any new entries on the VFD screen that are not yet accepted by use of the *Enter* button.

Figure 4-1 shows the hierarchy of functions available to the operator via the function buttons. The six function buttons on the analyzer are:

- *Analyze*. This is the normal operating mode. The analyzer monitors the oxygen content of the sample, displays the percent of oxygen, and warns of any alarm conditions.
- *System*. The system function consists of six subfunctions that regulate the internal operations of the analyzer:
 - Auto-Cal setup
 - Password assignment
 - Self-Test initiation
 - Checking software version
 - Logging out.
- *Zero*. Used to set up a zero calibration.
- *Span*. Used to set up a span calibration.
- *Alarms*. Used to set the alarm setpoints and determine whether each alarm will be active or defeated, HI or LO acting, latching, and/or failsafe.
- *Range*. Used to set up three analysis ranges that can be switched automatically with auto-ranging or used as individual fixed ranges.

Any function can be selected at any time by pressing the appropriate button (unless password restrictions apply). The order as presented in this manual is appropriate for an initial setup.

Each of these functions is described in greater detail in the following procedures. The VFD screen text that accompanies each operation is reproduced, at the appropriate point in the procedure, in a Monospaced type style. Pushbutton names are printed in *Oblique* type.

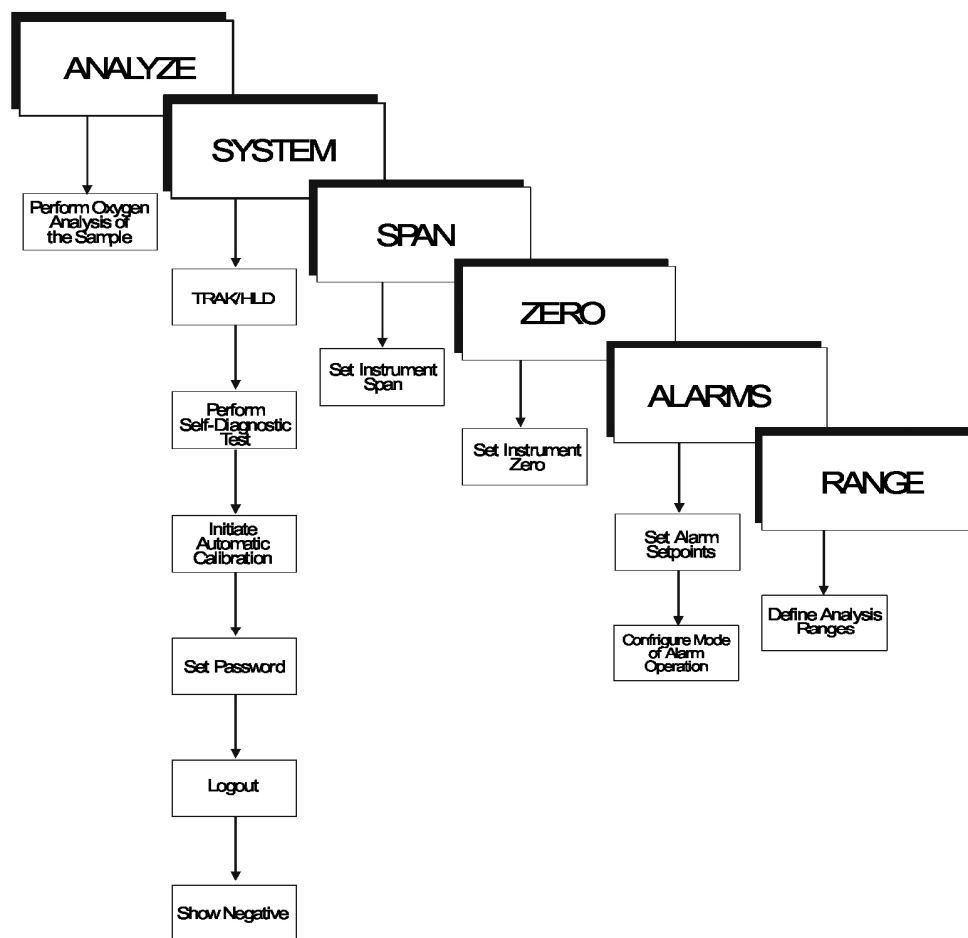

Figure 4-1: Hierarchy of Functions and Sub functions

4.3 The System Function

The subfunctions of the *System* function are described below. Specific procedures for their use follow the descriptions:

- **Auto-Cal:** Used to define an automatic calibration sequence and/or start an Auto-Cal.
- **PSWD:** Security can be established by choosing a 5 digit password (PSWD) from the standard ASCII character set.

(See Installing or Changing a Password, below, for a table of ASCII characters available.) Once a unique password is assigned and activated, the operator **MUST** enter the **UNIQUE** password to gain access to set-up functions which alter the instrument's operation, such as setting the instrument span or zero setting, adjusting the alarm setpoints, or defining analysis ranges.

After a password is assigned, the operator must log out to activate it. Until then, anyone can continue to operate the instrument without entering the new password.

Only one password can be defined. Before a unique password is assigned, the system assigns **TETAI** by default. This allows access to anyone. After a unique password is assigned, to defeat the security, the password must be changed back to **TETAI**.

- **Logout:** Logging out prevents an unauthorized tampering with analyzer settings.
- **More:** Select and enter **More** to get a new screen with additional subfunctions listed.
- **Self-Test:** The instrument performs a self-diagnostic test to check the integrity of the power supply, output boards and amplifiers.
- **Version:** Displays Manufacturer, Model, and Software Version of the instrument.
- **Show Negative:** The operator selects whether display can show negative oxygen readings or not.
- **TRAK/HLD:** The operator sets whether the instrument analog outputs track the concentration change during calibration and sets a time delay for the concentration alarms after calibration

4.3.1 Tracking Oxygen Readings During Calibration and Alarm Delay

The user has the option of setting the preference as to whether the analog outputs track the display readings during calibration or not. To set the preference, press the System key once and the first System menu will appear in the VFD display:

TRAK/HLD Auto-Cal

PSWD Logout More

TRAK/HLD should be blinking. To enter this system menu press the *Enter* key once:

Output Sttng: TRACK

Alarm Dly: 10 min

or

Output Sttng: HOLD

Alarm Dly: 10 min

In the first line, TRACK or HOLD should be blinking. The operator can toggle between TRACK and HOLD with the Up or Down keys. When TRACK is selected, the analog outputs (0-1 VDC and 4-20 mA) and the range ID contacts will track the instrument readings during calibration (either zero or span). TRACK is the factory default.

When HOLD is selected, the analog outputs (0-1 VDC and 4-20 mA) and the range ID contacts will freeze on their last state before entering one of the calibration modes. When the instrument returns to the Analyze mode, either by a successful or an aborted calibration, there will be a three-minute delay before the analog outputs and the range ID contacts start tracking again.

The concentration alarms freeze on their last state before entering calibration regardless of selecting HOLD or TRACK. But, when HOLD is selected the concentration alarms will remain frozen for the time displayed in the second line of the TRAK/HLD menu after the analyzer returns to the Analyze mode.

The factory default is three minutes, but the delay time is programmable. To adjust to delay time use the Left or Right arrow keys. When the time displayed on the second line blinks, it can be adjusted by Pressing the Up or Down keys to increase or decrease its value. The minimum delay is 1 minute, the maximum is 30.

This preference is stored in non-volatile memory so that it is recovered if power is removed from the instrument.

4.3.2 Setting up an Auto-Cal

When proper automatic valving is connected (see Chapter 3, *Installation*), the analyzer can cycle itself through a sequence of steps that automatically zero and span the instrument.

Note: If you require highly accurate Auto-Cal timing, use external Auto-Cal control where possible. The internal clock in the Model 3000TB is accurate to 2-3 %. Accordingly, internally scheduled calibrations can vary 2-3 % per day.

To setup an Auto-Cal cycle:

Choose **System** from the Function buttons. The LCD will display five subfunctions.

TRAK/HLD Auto-Cal
PSWD Logout More

Use ◀▶ arrows to blink Auto-Cal, and press **Enter**. A new screen for Span/Zero set appears.

Span OFF Nxt: 0d 0h
Zero OFF Nxt: 0d 0h

Press ◀▶ arrows to blink Span (or Zero), then press **Enter** again. (You won't be able to set OFF to ON if a zero interval is entered.) A Span Every ... (or Zero Every ...) screen appears.

Span Every 0 d
Start 0 h from now

Use ▲/▼ arrows to set an interval value, then use ◀▶ arrows to move to the start-time value. Use ▲/▼ arrows to set a start-time value.

To turn ON the Span and/or Zero cycles (to activate Auto-Cal): Press **System** again, choose Auto-Cal, and press **Enter** again. When the Span/ Zero values screen appears, use the ◀▶ arrows to blink the Span (or Zero) OFF/ON field. Use ▲/▼ arrows to set the OFF/ON field to ON. You can now turn these fields ON because there is a nonzero span interval defined.

4.3.3 Password Protection

If a password is assigned, then setting the following system parameters can be done only after the password is entered: **span** and **zero** settings, **alarm** setpoints, analysis **range** definitions, switching between **autoranging** and manual override, setting up an **auto-cal**, and assigning a new **password**. However, the instrument can still be used for analysis or for initiating a self- test without entering the password.

If you have decided not to employ password security, use the default password TETAI. This password will be displayed automatically by the microprocessor. The operator just presses the *Enter* key to be allowed total access to the instrument's features.

Note: If you use password security, it is advisable to keep a copy of the password in a separate, safe location.

4.3.3.1 ENTERING THE PASSWORD

To install a new password or change a previously installed password, you must key in and *Enter* the old password first. If the default password is in effect, pressing the *Enter* button will enter the default TETAI password for you.

Press *System* to enter the *System* mode.

TRAK/HLD Auto—Cal

PSWD Logout More

Use the ◀▶ arrow keys to scroll the blinking over to PSWD, and press *Enter* to select the password function. Either the default TETAI password or AAAAA place holders for an existing password will appear on screen depending on whether or not a password has been previously installed.

T E T A I

Enter PWD

or

A A A A A

Enter PWD

The screen prompts you to enter the current password. If you are not using password protection, press *Enter* to accept TETAI as the default password. If a password has been previously installed, enter the password using the ◀▶ arrow keys to scroll back and forth between letters, and the ▲/▼ arrow keys to change the letters to the proper password. Press *Enter* to enter the password.

If the password is accepted, the screen will indicate that the password restrictions have been removed and you have clearance to proceed.

PSWD Restrictions

Removed

In a few seconds, you will be given the opportunity to change this password or keep it and go on.

Change Password?

<ENT>=Yes <ESC>=No

Press *Escape* to move on, or proceed as in *Changing the Password*, below.

4.3.3.2 INSTALLING OR CHANGING THE PASSWORD

If you want to install a password, or change an existing password, proceed as above in *Entering the Password*. When you are given the opportunity to change the password:

Change Password?

<ENT>=Yes <ESC>=No

Press *Enter* to change the password (either the default TETAI or the previously assigned password), or press *Escape* to keep the existing password and move on.

If you chose *Enter* to change the password, the password assignment screen appears.

T E T A I
 <ENT> To Proceed
 or
 A A A A A
 <ENT> To Proceed

Enter the password using the ◀▶ arrow keys to move back and forth between the existing password letters, and the ▲/▼ arrow keys to change the letters to the new password. The full set of 94 characters available for password use are shown in the table below.

Characters Available for Password Definition:

A	B	C	D	E	F	G	H	I	J
K	L	M	N	O	P	Q	R	S	T
U	V	W	X	Y	Z	[¥]	^
	`	a	b	c	d	e	f	g	h
i	j	k	l	m	n	o	p	q	r
s	t	u	v	w	x	y	z	{	
}	_	!	"	#	\$	%	&	'	(
)	*	+	,	-	.	/	0	1	2
3	4	5	6	7	8	9	:	;	<
=	>	?	@						

When you have finished typing the new password, press *Enter*. A verification screen appears. The screen will prompt you to retype your password for verification.

A A A A A
 Retype PWD To Verify

Wait a moment for the entry screen. You will be given clearance to proceed.

A A A A
<ENT> To Proceed

Use the arrow keys to retype your password and press *Enter* when finished. Your password will be stored in the microprocessor and the system will immediately switch to the *Analyze* screen, and you now have access to all instrument functions.

If all alarms are defeated, the *Analyze* screen appears as:

0.0 ppm Anlz
Range: 0 — 100

If an alarm is tripped, the second line will change to show which alarm it is:

0.0 ppm Anlz
AL—1

Note: If you log off the system using the logout function in the system menu, you will now be required to re-enter the password to gain access to Span, Zero, Alarm, and Range functions.

4.3.4 Logout

The Logout function provides a convenient means of leaving the analyzer in a password protected mode without having to shut the instrument off. By entering Logout, you effectively log off the instrument leaving the system protected against use until the password is reentered. To log out, press the *System* button to enter the *System* function.

TRAK/HLD Auto—Cal
PSWD Logout More

Use the ◀▶ arrow keys to position the blinking over the Logout function, and press *Enter* to Log out. The screen will display the message:

**Protected Until
Password Reentered**

4.3.5 System Self-Diagnostic Test

The Model 3000TB has a built-in self-diagnostic testing routine. Pre-programmed signals are sent through the power supply, output board and sensor circuit. The return signal is analyzed, and at the end of the test the status of each function is displayed on the screen, either as OK or as a number between 1 and 3. (See *System Self Diagnostic Test* in chapter 5 for number code).

The self diagnostics are run automatically by the analyzer whenever the instrument is turned on, but the test can also be run by the operator at will. To initiate a self diagnostic test during operation:

Press the *System* button to start the *System* function.

**TRAK/HLD Auto—Cal
PSWD Logout More**

Use the ◀▶ arrow keys to blink *More*, then press *Enter*.

Version Self—Test

Use the ◀▶ arrow keys again to move the blinking to the *Self—Test* function. The screen will follow the running of the diagnostic.

**RUNNING DIAGNOSTIC
Testing Preamp — 83**

During preamp testing there is a countdown in the lower right corner of the screen. When the testing is complete, the results are displayed.

Power: OK Analog: OK
Preamp: 3

The module is functioning properly if it is followed by OK. A number indicates a problem in a specific area of the instrument. Refer to Chapter 5 *Maintenance and Troubleshooting* for number-code information. The results screen alternates for a time with:

Press Any Key
To Continue...

Then the analyzer returns to the initial System screen.

4.3.6 Version Screen

Move the ◀▶ arrow key to More and press *Enter*. With Version blinking, press *Enter*. The screen displays the manufacturer, model, and software version information.

4.3.7 Showing Negative Oxygen Readings

For software version 1.4.4 or later, the instrument only displays oxygen readings that are positive or zero. The instrument can be reconfigured to show negative readings if sensor output drifts below zero. This situation may arise after the instrument has been zeroed, as time progresses the sensor may drift below the zero calibration setpoint.

To show negative oxygen readings on the display:

Press the *System* key.

TRAK/HLD Auto-Cal
PSWD Logout More

Use the Right or Left arrow keys and select More. Press *Enter*.

Version Self-Test**Show_Negative=NO**

Use the ◀ / ▶ Arrow keys and select “Show_Negative=NO”.

Use the ▲ / ▼ keys to toggle from NO to YES.

Press the *Escape* key twice to return to the analyze mode.

This preference is stored in non-volatile memory, so this configuration is remembered after a power shutdown. If the instrument is cold started, it will go back to default (not showing negative oxygen readings).

4.4 The Zero and Span Functions

Note: Zeroing is not required in order to achieve the published accuracy specification of this unit.

Zeroing will eliminate offset error contributed by sensor, electronics, and internal and external sampling system and improve performance beyond published specification limits.

The analyzer is calibrated using zero and span gases.

Any suitable oxygen-free gas can be used for zero gas as long as it is known to be oxygen free and does not react adversely with the sample system.

Although the instrument can be spanned using air, a span gas with a known oxygen concentration in the range of 70–90% of full scale of the range of interest is recommended. Since the oxygen concentration in air is 20.9% (209,000 ppm), the cell can take a long time to recover if the instrument is used for trace oxygen analysis immediately following calibration in air.

Connect the calibration gases according to the instructions given in Section 3.5, *Gas Connections*, observing all the prescribed precautions.

Shut off the gas pressure before connecting it to the analyzer, and be sure to limit the pressure to 40 psig or less when turning it back on.

Readjust the gas pressure into the analyzer until the flowrate (as read on the analyzer’s SLPM flowmeter) settles between 0.5 and 2.4 SLPM (approximately 1 - 5 SCFH).

If you are using password protection, you will need to enter your password to gain access to either of these functions. Follow the instructions in Sections 4.3.3 to enter your password. Once you have gained clearance to proceed, you can enter the *Zero* or *Span* function.

4.4.1 Zero Cal

The *Zero* button on the front panel is used to enter the zero calibration function. Zero calibration can be performed in either the automatic or manual mode. In the **automatic** mode, an internal algorithm compares consecutive readings from the sensor to determine when the output is within the acceptable range for zero. In the **manual** mode, the operator determines when the reading is within the acceptable range for zero. Make sure the zero gas is connected to the instrument. If you get a CELL FAILURE message skip to Section 4.4.1.3.

4.4.1.1 AUTO MODE ZEROING

Press *Zero* to enter the zero function mode. The screen allows you to select whether the zero calibration is to be performed automatically or manually. Use the ▲/▼ arrow keys to toggle between AUTO and MAN zero settling. Stop when AUTO appears, blinking, on the display.

Zero: Settling: AUTO

<ENT> To Begin

Press *Enter* to begin zeroing.

####PPM Zero

Slope=#### ppm/s

The beginning zero level is shown in the upper left corner of the display. As the zero reading settles, the screen displays and updates information on **Slope** (unless the Slope starts within the acceptable zero range and does not need to settle further).

Then, and whenever Slope is less than 0.08 for at least 3 minutes, instead of Slope you will see a countdown: 5 Left, 4 Left, and so forth. These are five steps in the zeroing process that the system must complete, AFTER settling, before it can go back to *Analyze*.

```
####PPM Zero
4 Left=###      ppm/s
```

The zeroing process will automatically conclude when the output is within the acceptable range for a good zero. Then the analyzer automatically returns to the *Analyze* mode.

4.4.1.2 MANUAL MODE ZEROING

Press *Zero* to enter the *Zero* function. The screen that appears allows you to select between automatic or manual zero calibration. Use the ▲/▼ keys to toggle between AUTO and MAN zero settling. Stop when MAN appears, blinking, on the display.

```
Zero: Settling: Man
<ENT> To Begin
```

Press *Enter* to begin the zero calibration. After a few seconds the first of five zeroing screens appears. The number in the upper left hand corner is the first-stage zero offset. The microprocessor samples the output at a predetermined rate. It calculates the differences between successive samplings and displays the rate of change as **Slope=** a value in parts per million per second (ppm/s).

```
#### ppm Zero
Slope=#### ppm/s
```

Note: It takes several seconds for the true Slope value to display. Wait about 10 seconds. Then, wait until Slope is sufficiently close to zero before pressing Enter to finish zeroing.

Generally, you have a good zero when Slope is less than 0.05 ppm/s for about 30 seconds. When Slope is close enough to zero, press *Enter*. In a few seconds, the screen will update.

Once span settling completes, the information is stored in the microprocessor, and the instrument automatically returns to the *Analyze* mode.

4.4.1.3 CELL FAILURE

Cell failure in the 3000TB is usually associated with inability to zero the instrument down to a satisfactorily low ppm reading. When this occurs, the 3000TB system alarm trips, and the LCD displays a failure message.

ppm Anlz
CELL FAIL/ ZERO HIGH

Before replacing the cell:

- Check your span gas to make sure it is within specifications.
- Check for leaks downstream from the cell, where oxygen may be leaking into the system.

If there are no leaks and the span gas is OK, replace the cell as described in chapter 5, *Maintenance*.

4.4.2 Span Cal

The *Span* button on the front panel is used to span calibrate the analyzer. Span calibration can be performed using the **automatic** mode, where an internal algorithm compares consecutive readings from the sensor to determine when the output matches the span gas concentration. Span calibration can also be performed in **manual** mode, where the operator determines when the span concentration reading is acceptable and manually exits the function.

4.4.2.1 AUTO MODE SPANNING

Press *Span* to enter the span function. The screen that appears allows you to select whether the span calibration is to be performed automatically or manually. Use the ▲/▼ arrow keys to toggle between AUTO and MAN span settling. Stop when AUTO appears, blinking, on the display.

Span: Settling: AUTO
<ENT> For Next

Press *Enter* to move to the next screen.

Calib. Holding time

Cal hold: 5 min

This menu allows the operator to set the time the analyzer should be held in the span mode, after the readings of the analyzer settle. Five minutes is the default, but it could be adjusted anywhere from 1 to 60 minutes by using the ▲/▼ keys. (A longer cal holding time will result in a slightly more accurate calibration. Five minutes is appropriate for most users and applications.)

Press *Enter* to move to the next screen.

Span Val: 000008.00

<ENT>Span <UP>Mod #

Use the ▲/▼ arrow keys to enter the oxygen-concentration mode. Use the ◀▶ arrow keys to blink the digit you are going to modify. Use the ▲/▼ arrow keys again to change the value of the selected digit. When you have finished typing in the concentration of the span gas you are using (209000.00 if you are using air), press *Enter* to begin the Span calibration.

ppm Span
Slope=#### ppm/s

The beginning span value is shown in the upper left corner of the display. As the span reading settles, the screen displays and updates information on **Slope**. Spanning automatically ends when the span output corresponds, within tolerance, to the value of the span gas concentration. Then the instrument automatically returns to the analyze mode.

4.4.2.2 MANUAL MODE SPANNING

Press *Span* to start the *Span* function. The screen that appears allows you to select whether the span calibration is to be performed automatically or manually.

Span: Settling:MAN

<ENT> For Next

Use the ▲/▼ keys to toggle between AUTO and MAN span settling. Stop when MAN appears, blinking, on the display. Press *Enter* to move to the next screen.

Press *Enter* to move to the next screen.

Calib. Holding time

Cal hold: 5 min

This menu allows the operator to set the time the analyzer should be held in the auto span mode. It does not affect anything in Manual Mode. Just press *Enter* to continue.

Span Val: 000008.00

<ENT>Span <UP>Mod #

Press ▲ (<UP>) to permit modification (Mod #) of span value.

Use the arrow keys to enter the oxygen concentration of the span gas you are using (209000.00 if you are using air). The ◀ / ▶ arrows choose the digit, and the ▲/▼ arrows choose the value of the digit.

Press *Enter* to enter the span value into the system and begin the span calibration.

Once the span has begun, the microprocessor samples the output at a predetermined rate. It calculates the difference between successive samplings and displays this difference as Slope on the screen. It takes several seconds for the first Slope value to display. Slope indicates rate of change of the Span reading. It is a sensitive indicator of stability.

% Span
Slope=#### ppm/s

When the Span value displayed on the screen is sufficiently stable, press *Enter*. (Generally, when the Span reading changes by 1% or less of the full scale of the range being calibrated for a period of ten minutes it is sufficiently stable.) Once *Enter* is pressed, the Span reading changes to the correct value. The instrument then automatically enters the Analyze function.

4.4.3 Span Failure

The analyzer checks the output of the cell at the end of the span. If the raw output of the cell is less than 0.5 uA/ppm O₂, the span will not be accepted. The analyzer will return to the previous calibration values, trigger the System Alarm, and display in the VFD:

Span Failed!!

This message will be shown for five seconds and the instrument will return to the Analyze mode. In the upper right hand corner of the VFD display “FCAL” will be shown. This message flag will help the operator troubleshoot in case calibration was initiated remotely. To reset the alarm and the flag message, the unit must be turned off by cycling the standby key . It will reset if the next span cycle is correct.

A trace cell is unlikely to fail span. As explained before, when the sensor reaches the end of its useful life, the zero offset begins to rise until the analyzer finds the zero unsatisfactory. Nevertheless, feeding the wrong span gas or electronics failure could set this feature off at the end of the span. Consider this before replacing the cell.

4.5 The Alarms Function

The Model 3000TB is equipped with 2 fully adjustable concentration alarms and a system failure alarm. Each alarm has a relay with a set of form “C” contacts rated for 3 amperes resistive load at 250 V ac. See Figure 3-6 in Chapter 3 *Installation* and/or the Interconnection Diagram included at the back of this manual for relay connections.

The system failure alarm has a fixed configuration described in Chapter 3 *Installation*.

The concentration alarms can be configured from the front panel as either high or low alarms by the operator. The alarm modes can be set as latching or non-latching, and either failsafe or non-failsafe, or, they can be defeated altogether. The setpoints for the alarms are also established using this function.

Decide how your alarms should be configured. The choice will depend upon your process. Consider the following four points:

1. Which if any of the alarms are to be high alarms and which if any are to be low alarms?

Setting an alarm as HIGH triggers the alarm when the oxygen concentration rises above the setpoint. Setting an alarm as LOW triggers the alarm when the oxygen concentration falls below the setpoint.

Decide whether you want the alarms to be set as:

- Both high (high and high-high) alarms, or
- One high and one low alarm, or
- Both low (low and low-low) alarms.

2. Are either or both of the alarms to be configured as failsafe?

In failsafe mode, the alarm relay de-energizes in an alarm condition. For non-failsafe operation, the relay is energized in an alarm condition. You can set either or both of the concentration alarms to operate in failsafe or non-failsafe mode.

3. Are either of the alarms to be latching?

In latching mode, once the alarm or alarms trigger, they will remain in the alarm mode even if process conditions revert back to non-alarm conditions. This mode requires an alarm to be recognized before it can be reset. In the non-latching mode, the alarm status will terminate when process conditions revert to non- alarm conditions.

4. Are either of the alarms to be defeated?

The defeat alarm mode is incorporated into the alarm circuit so that maintenance can be performed under conditions which would normally activate the alarms.

The defeat function can also be used to reset a latched alarm.
(See procedures, below.)

If you are using password protection, you will need to enter your password to access the alarm functions. Follow the instructions in section 4.3.3 to enter your password. Once you have clearance to proceed, enter the Alarm function.

Press the Alarm button on the front panel to enter the Alarm function. Make sure that AL-1 is blinking.

```
AL-1      AL-2
Choose Alarm
```

Set up alarm 1 by moving the blinking over to AL-1 using the ◀ / ▶ arrow keys. Then press *Enter* to move to the next screen.

```
AL-1 1000      ppm HI
Dft-N  Fs-N  Ltch-N
```

Five parameters can be changed on this screen:

- Value of the alarm setpoint, AL-1 ##### ppm (oxygen)
- Out-of-range direction, HI or LO
- Defeated? Dft-Y/N (Yes/No)
- Failsafe? Fs-Y/N (Yes/No)
- Latching? Ltch-Y/N (Yes/No).

To define the setpoint, use the ◀ / ▶ arrow keys to move the blinking over to AL-1 #####. Then use the ▲/▼ arrow keys to change the number. Holding down the key speeds up the incrementing or decrementing. (Remember, the setpoint units are ppm O₂.)

To set the other parameters use the ◀ / ▶ arrow keys to move the blinking over to the desired parameter. Then use the ▲/▼ arrow keys to change the parameter.

Once the parameters for alarm 1 have been set, press *Alarms* again, and repeat this procedure for alarm 2 (AL-2).

To reset a latched alarm, go to Dft- and then press either ▲ two times or ▼ two times. (Toggle it to Y and then back to N.)

–OR–

Go to Ltch– and then press either ▲ two times or ▼ two times.
(Toggle it to N and back to Y.)

4.6 The Range Function

The Range function allows the operator to program up to three concentration ranges to correlate with the DC analog outputs. If no ranges are defined by the user, the instrument defaults to:

Low = 0–100 ppm

Med = 0–1,000 ppm

High = 0–10,000 ppm

The Model 3000TB is set at the factory to default to autoranging. In this mode, the microprocessor automatically responds to concentration changes by switching ranges for optimum readout sensitivity. If the current range limits are exceeded, the instrument will automatically shift to the next higher range. If the concentration falls to below 85% of full scale of the next lower range, the instrument will switch to that range. A corresponding shift in the DC percent-of-range output, and in the range ID outputs, will be noticed.

The autoranging feature can be overridden so that analog output stays on a fixed range regardless of the oxygen concentration detected. If the concentration exceeds the upper limit of the range, the DC output will saturate at 1 VDC (20 mA at the current output).

However, the digital readout and the RS-232 output of the concentration are unaffected by the fixed range. They continue to read accurately with full precision. See section 1.5 *Front Panel* in Chapter 1 for a description.

The automatic air calibration range is always 0-25 % and is not programmable.

4.6.1 Setting the Analog Output Ranges

To set the ranges, enter the range function mode by pressing the *Range* button on the front panel.

L–100 M–1000
H–1 0000 Mode–AUTO

Use the ◀ / ▶ arrow keys to blink the range to be set: low (L), medium (M), or high (H).

Use the ▲ / ▼ arrow keys to enter the upper value of the range (all ranges begin at 0 ppm). Repeat for each range you want to set. Press *Enter* to accept the values and return to *Analyze* mode. (See note below.)

Note: The ranges must be increasing from low to high, for example, if range 1 is set as 0–100 ppm and range 2 is set as 0–1,000 ppm, range 3 cannot be set as 0–500 ppm since it is lower than range 2.

Ranges, alarms, and spans are always set in ppm units (over the entire 0-250,000 ppm range), even though all concentration-data outputs change from ppm units to percent when the concentration is above 10,000 ppm.

4.6.2 Fixed Range Analysis

The autoranging mode of the instrument can be overridden, forcing the analyzer DC outputs to stay in a single predetermined range.

To switch from autoranging to fixed range analysis, enter the range function by pressing the *Range* button on the front panel.

Use the ◀ / ▶ arrow keys to move the blinking over AUTO.

Use the ▲ / ▼ arrow keys to switch from AUTO to FX/LO, FX/M ED, or FX/H I to set the instrument on the desired fixed range (low, medium, or high).

L—100 M—1000
H—1 0000 Mode—FX/ LO

or

L—100 M—1000
H—1 0000 Mode—FX/MED

or

L—100 M—1000
H—1 0000 Mode—FX/ HI

Press *Escape* to re-enter the *Analyze* mode using the fixed range.

Note: When performing analysis on a fixed range, if the oxygen concentration rises above the upper limit (or default value) as established by the operator for that particular range, the output saturates at 1 VDC (or 20 mA). However, the digital readout and the RS-232 output continue to read the true value of the oxygen concentration regardless of the analog output range.

4.7 The Analyze Function

This is the normal operating mode of the analyzer. In this Mode, the analyzer is monitoring the sample, measuring and displaying the amount of oxygen, and reporting alarm conditions.

Normally, all of the functions automatically switch back to the *Analyze* function when they have completed their assigned operations. Pressing the *Escape* button in many cases also switches the analyzer back to the *Analyze* function. Alternatively, you can press the *Analyze* button at any time to return to analyzing your sample.

IMPORTANT: *In the event of loss of flow through the analyzer, if the vent is vented to a location of high oxygen content, oxygen will back diffuse through the vent line and in most cases quickly saturate the cell with oxygen which can then require a quite long purge down time for the sensor when then exposed to low oxygen concentrations. In the event that flow is to be interrupted into the analyzer, it is suggested that the user do one of the following:*



- 1. Bag the sensor in nitrogen during this time*
- 2. Install a shut off valve on the vent port of the analyzer or somewhere within the users sample system.*

4.8 Maintenance Schedule

The Maintenance function offers the user the ability to set a screen notification after a user-defined period that the sensor needs replacement. For instance, after installing a new sensor, the user can set a defined

interval (6 months is the default setting) after which a notification on the *Analyze* screen will advise that sensor maintenance is needed. This function can be set so that in addition to the notification, it also triggers the system failure alarm. It can also be turned off.

To access the Maintenance function use the Use the ◀ / ▶ arrow keys to navigate to the fourth *System* menu.

Maintenance Serial#
Stream SerMode More

Use the RIGHT button to move the blinking to Maintenance and then press *Enter* to go to the next screen.

Set: M: 0 D: 7 On
Nxt: M: 0 D: 6 Reset

The timer in the maintenance function is set in months (M) and days (D) on the top line of the display. The maximum setting is M=30 and D=30. The default is M=6 and D=0. The user has the option of turning the function On or Off or to have it trigger the system alarm (Alarm).

To change the notification period, use the RIGHT arrow key to move the blinking to the appropriate field M(onth) or D(ay) and then use the ▲/▼ keys to increment or decrement the value. Press *Enter* when the appropriate setting is displayed.

The second line is the actual countdown and displays the time left before a notification or alarm will occur. It counts down until the Maintenance warning is set. To re-start the counter the operator must select “Reset” and press *Enter*. The operator is prompted to press *Enter* again to re-affirm the restart of the counter.

Reset Maint Timeout?
<ENT> Yes <ESC> No

Pressing ESC will return you to the previous screen.

There are three modes to the Maintenance counter: Off, On, and Alarm.

- OFF: Turns off the counter, thus Maintenance mode is off.
- ON: Turns on the counter but at the end of the countdown “MAINT” is shown on the display but the System alarm contacts are not triggered.
- Alarm: Turns ON the counter and will display “MAINT” on the *Analyze* screen at the end of the countdown plus trigger the system alarm contacts.

In this mode, when the counter reaches M:0 and D:0, the system alarm contact is triggered and the upper right corner of the display in *Analyze* mode will have the normal “Anlz” replaced by “MAINT”.

Note: The system alarm can be reset only after the timer has been reset.

0.00 ppm MAINT

Range: 0 - 100

4.9 Sensor Detection

The sensor detection feature detects whether a sensor is installed in the analyzer or not. The software checks if the output of the amplifier is within a user-defined threshold around the electronic zero (output of the amplifier without sensor). In the event that the sensor reads a near zero (or below the user-defined threshold) ADC count for 30 minutes it will trigger a system failure alarm with a corresponding message on the *Analyze* screen.

In this function, the user can set the count threshold below which the alarm will occur as well as reset the 30 minute timer back to 30 minutes.

Note: The 30 minute delay is set at the factory and cannot be modified.

The default threshold is set to 300 but can be increased or decreased by the user using this function. The sensor fail function can also be turned OFF or ON within this function.

To access the Sensor function, use the ◀ / ▶ arrow keys to navigate to the last *System* menu.

Sensor

Press *Enter*. The next screen will appear:

Sensor FAIL: ON

Thresh: 200 Reset

In this screen the featured can be turned on and off on the first line. The Sensor Detection feature is ON by default. To turn the alarm ON or OFF, use the ◀ / ▶ arrow keys to move the blinking to ON (or OFF). Press the ▲/▼ keys to toggle between ON and OFF. Press *Enter* to save your choice.

The detection window (Thresh) around the electronic zero level is set on the second line. It defaults to 300 but it can be adjusted. This numbers is the ADC counts on the A to D converter and it is equivalent to 0.114% of the full scale of the A to D converter.

Adjust the threshold for the alarm by moving the blinking over to the value adjacent to Thres:. Use the ▲/▼ keys to increase or decrease the threshold value. When the desired value is displayed, press *Enter* to save it.

The fixed 30 minute timer begins to count down to zero whenever the ADC sensor count falls below the set threshold. If within the countdown, the user sets a new and higher threshold or replaces the sensor to remedy the near zero output, the countdown timer can be reset back to 30 minutes manually using the Reset feature.

To reset the counter to 30, use the arrow keys to move the blinking to Reset and then press the *Enter* key.

The timer and the ADC counts can be displayed on the *Analyze* screen by pressing the *ESC* key twice.

```
6.09 ppm Anlz
1- 136730 30:00
```

The second line will display three numbers for a few seconds. The first number (1) is the gain of the amplifier (1 is the highest gain used for low ppm analysis).

The second number (136730) is the ADC count from the A to D converter.

The third number (30:00) is the timer in minutes: seconds, and this is the value that it shows when it is not triggered.

When the timer reaches 00:00, the system alarm is triggered and the message “FSEN“ and “ERRS” appear in the upper right corner of the display instead of “Anlz”.

```
0.01 ppm FSEN
Range: 0 - 100
```

```
0.01 ppm ERRS
Range: 0 - 100
```

To reset the message and the system alarm contacts, the operator must go back to the *Sensor* function in the system menu and select *Reset*, then press the *Enter* key. The display will be followed by a prompt to confirm the reset.

```
Reset Sensor Fail?
<ENT> Yes <ESC> No
```

4.10 Valve Box Functions

Three additional functions are available from the System Menu that are used exclusively with analyzers that interface with a Teledyne VB Valve Box or Teledyne Adapter Profibus (TAPA) board. These are:

- Serial #
- Stream

- SerMode (Serial Mode)

If your analyzer is not connected to a VB style valve box or have a TAPA interface installed, these functions will have no effect.

4.10.1 Serial#

At this screen, you can set the serial number of the analyzer so that it is passed on to a valve box through the RS232. The default value is 100000. The serial number can be found on a sticker either just inside opening the door of the analyzer or on the rear panel.

To enter the serial number navigate to the third *System* menu using the ◀ / ▶ keys and selecting *More* until the following display appears:

```
Maintenance Serial#  
Stream SerMode More
```

Use the ◀ / ▶ keys again to move to *Serial#* and press *Enter*. The Enter Serial Number screen will appear.

```
Enter Serial#  
100000
```

Use the ▲/▼ keys to enter the serial number and then press *Enter* to save.

4.10.2 Stream

The Stream function is useful when the analyzer is connected with a TAI Valve Box. It allows the user to switch the input stream from the analyzer rather than the Valve Box. This assumes that the analyzer is in local mode and not being controlled by an external source. If the analyzer is not interfaced with a Valve Box, this function has no input.

To enter the Stream function navigate to the third *System* menu using the ◀ / ▶ keys and selecting *More* until the following display appears:

Maintenance Serial#
Stream SerMode More

Use the ◀ / ▶ keys again to move to Stream and press *Enter*. The display will change to the following:

Select Sample Stream
1 Press <ENTER>

Use the ▲ / ▼ keys to display the proper valve to select (1,2 or 3). Then Press *Enter*. This will cause the valve controlling that stream to open.

4.10.3 SerMode

There are two serial communication modes available in the Model 3000TB: Profibus and standard RS232 (default).

The Profibus mode is used primarily in conjunction with a TAI Valve Box. It is used to communicate specific commands for controlling or receiving input from the Valve Box. This feature requires either special software or a Profibus Adapter Board (TAPA) available from TAI which converts the RS232 to Profibus and adds additional commands.

To view or change the current communication mode, use the ◀ / ▶ and *Enter* keys to navigate to the third *System* menu and select SerMode from the menu.

Serial Mode: Profi

or

Serial Mode: Std (RS232)

Use the ▲ / ▼ keys to toggle between Profi (Profibus) and Std (RS232), and then press *Enter*.

The RS232 defaults to support connectivity to Teledyne's Valve Box or Teledyne Adapter Profibus (TAPA) board.

Note that valve box or TAPA board support requires the baud rate to be set to 9600. Dip switches in motherboard must be set as shown below to change baud rate to 9600:

Position 1 set to ON

Position 2 to OFF

Position 3 to 8 set to OFF.

[BLANK PAGE]

Maintenance

5.1 Routine Maintenance

Aside from normal cleaning and checking for leaks at the gas connections, routine maintenance is limited to replacing Micro-Fuel cells and fuses, and recalibration. For recalibration, see Section 4.4 *The Zero and Span Functions*.

Warning: See warnings on the title page of this manual.



5.2 Major Internal Components

All internal components are accessed by unlatching and swinging open the front cover, as described earlier. The major internal component locations are shown in Figure 5-1, the cell block is illustrated in Figure 5-2, and the fuse receptacle is shown in Figure 5-3.

The 3000TB contains the following major internal components:

- Micro-Fuel Cell —Insta Trace P/N B71875 (std.)
- Stainless steel cell block
- Customer Interface PCB (Power Supply on bottom surface)
- Preamp PCB (Contains Microprocessor)
- Front Panel PCB (Contains Displays)
 - 5 digit LED meter
 - 2 line, 20 character, alphanumeric, VFD display
- Solenoid Operated Gas Control Valves (–C option only).

See the drawings in the Drawings section in back of this manual for details.

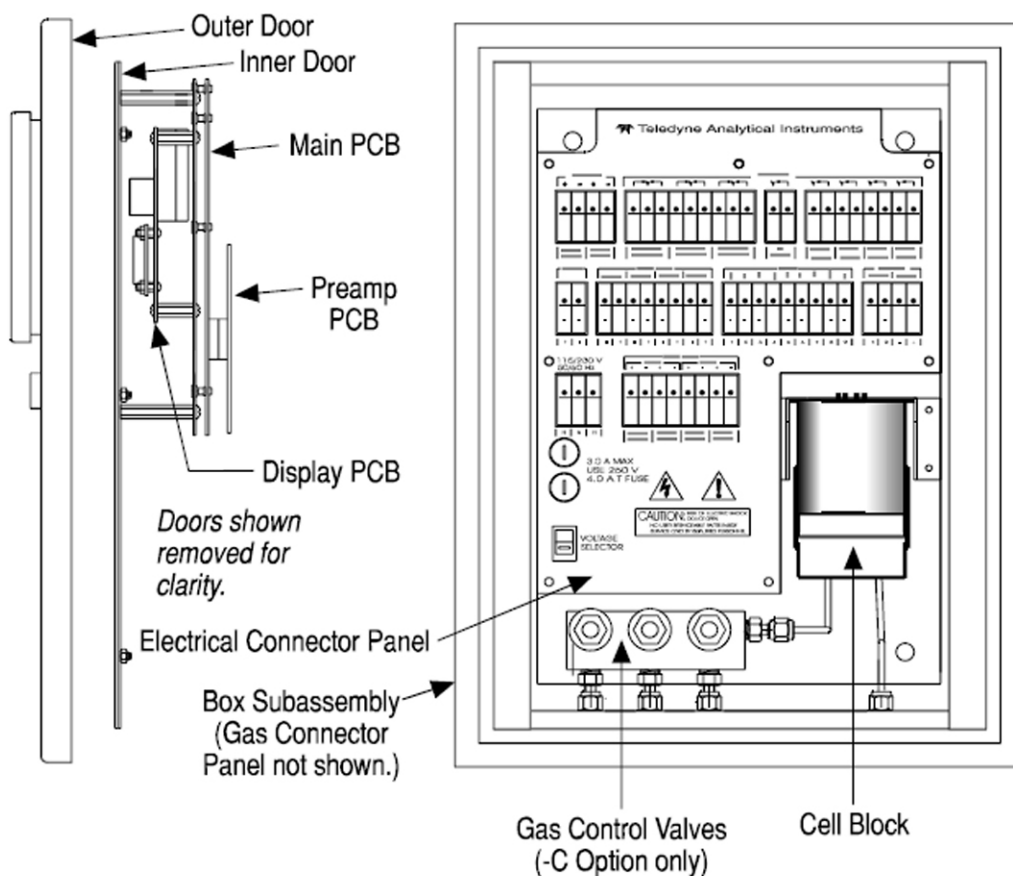

Figure 5-1: Major Internal Components

5.3 Cell Replacement

The Micro-Fuel Cell is a sealed electrochemical transducer with no electrolyte to change or electrodes to clean. When the cell reaches the end of its useful life, it is replaced. The spent fuel cell should be discarded according to local regulations. This section describes fuel cell care as well as when and how to replace it.

The Insta Trace (P/N B71875) Micro-Fuel Cell is used in the standard Model 3000TB. If any other cell is supplied with your instrument, check the front of this manual for any addenda applying to your special model.

5.3.1 Storing and Handling Replacement Cells

To have a replacement cell available when it is needed, it is recommended that one spare cell be purchased 9-10 months after commissioning the 3000TB, or shortly before the end of the cell's one year warranty period.

CAUTION: DO NOT STOCKPILE CELLS. THE WARRANTY PERIOD STARTS ON THE DAY OF SHIPMENT.



The spare cell should be carefully stored in an area that is not subject to large variations in ambient temperature (75°F nominal, 24°C) or to rough handling.

WARNING: *The sensor used in the model 3000TB Trace Oxygen Analyzer uses electrolytes which contain toxic substances, mainly Lead and potassium hydroxide, that can be harmful if touched, swallowed, or Inhaled. Avoid contact with any fluid or powder in or around the unit. What may appear to be plain water could contain one of these toxic substances. In case of eye contact, immediately flush eyes with water for at least 15 minutes. Call physician. (See appendix, Material Safety Data Sheet.)*



CAUTION: DO NOT DISTURB THE INTEGRITY OF THE CELL PACKAGE UNTIL THE CELL IS TO ACTUALLY BE USED. IF THE CELL PACKAGE IS PUNCTURED AND AIR IS PERMITTED TO ENTER, THE CELL WILL REQUIRE AN EXCESSIVELY LONG TIME TO REACH ZERO AFTER INSTALLATION (1-2 WEEKS!).



5.3.2 When to Replace a Cell

The characteristics of the Micro-Fuel Cell show an almost constant output throughout its useful life and then fall off sharply towards zero at the end. Cell failure in the 3000TB is usually characterized inability to zero the instrument down to a satisfactorily low ppm reading. When this occurs, the 3000TB system alarm trips, and the LCD displays a failure message.

ppm Anlz

CELL FAIL/ ZERO HIGH

Before replacing the cell:

- a) Check your span gas to make sure it is within specifications.
- b) Check for leaks downstream from the cell, where oxygen may be leaking into the system.

If there are no leaks and the span gas is OK, replace the cell. The only way to avoid all fail messages is to turn the unit off and then back on.

5.3.3 Removing the Micro-Fuel Cell

The Micro-Fuel cell is located inside the stainless steel cell block behind the front panel (see Figure 5-1). To remove an existing cell:

1. Remove power to the instrument by unplugging the power cord at the power source.
2. Open the inner door by unlatching it and swinging it open on its hinges.
3. Leave the cell block installed. Place one hand underneath the cell block, ready to catch the cell holder and Micro-Fuel Cell.
4. Lift up on the stainless steel gate in front of the cell block. This releases the cell and cell holder from the block. The cell and holder will fall into your hand.

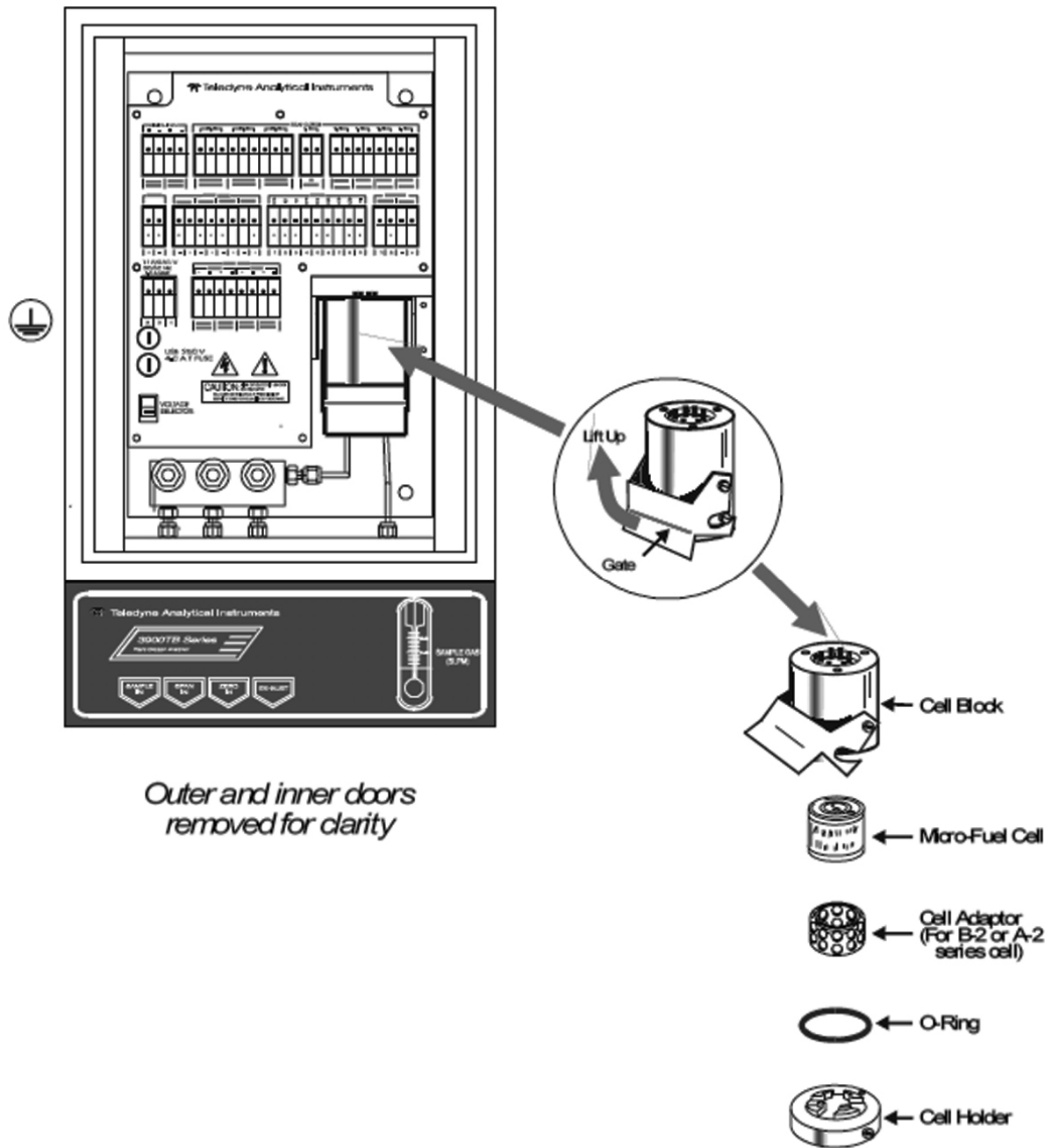

Figure 5-2: Exploded View of Cell Block and Micro-Fuel Cell

5.3.4 Installing a New Micro-Fuel Cell

It is important to minimize the amount of time that a Teledyne Trace Oxygen Sensor is exposed to air during the installation process. The quicker the sensor can be installed into the unit, the faster your TAI O₂ sensor will recover to low O₂ measurement levels.

CAUTION: **DO NOT TOUCH THE SENSING SURFACE OF THE CELL. IT IS COVERED WITH A DELICATE TEFLON MEMBRANE THAT CAN LEAK WHEN PUNCTURED. THE SENSOR MUST BE REPLACED IF THE MEMBRANE IS DAMAGED.**



Before installing a new cell, check the O-ring in the base of the cell holder. Replace if worn or damaged.

Place the cell on the holder with the screen side facing down.

Note: There is a small location hole drilled in the holder. This hole mates with a guide pin on the bottom rear of the cell block. The hole in the cell block holder must align with the guide pin on the cell block.

1. Remove power from instrument.
2. Remove the old sensor (if installed) from the analyzer.
3. Purge the analyzer at approximately 1 SCFH flow rate with N₂ (or zero gas with the sensor holder removed).
4. Remove sensor from double bag storage.
5. Remove sensor shorting button.
6. Place sensor on sensor holder so that the gold contact plate of the sensor is facing up towards the sky.
7. Install sensor and sensor holder into cell block.
8. With O-ring in place, align the guide pin with the hole on the cell holder. Then, with the holder, lift cell into the cell block.
9. Push the gate on the cell block down so that the slots on the side of the gate engage the locating screws on the side of the block. This forces the holder into position and forms a gastight seal.
10. Purge system with sample or zero gas.
11. Power-up.

Note: If steps 4 through 10 are accomplished quickly (elapsed time less than 15 seconds), recovery to less than 1ppm level should occur in less than 8 hours.

5.3.5 Cell Lifetime

The Insta Trace Micro-Fuel cell is used in the Model 3000TB. This cell has an expected lifetime of 6 months to 1 year from the date of installation. If any other cell is supplied with your instrument, check the front of this manual for special information applying to your cell.

This sensor is used for trace O₂ analysis in inert gas and hydrocarbon streams. Consult the factory for other applications.

With regard to spare cells, the warranty period begins on the date of shipment. The customer should purchase only one spare cell (per section 5.3.1). Do not attempt to stockpile spare cells.

If a cell was working satisfactorily but ceases to function prematurely within the warranty period, contact the factory. With any warranty claim, you must return the cell in question to the factory for evaluation. If it is determined that failure is due to faulty workmanship or material, the cell will be replaced at no cost to you.

Note: Evidence of damage due to tampering or mishandling will render the cell warranty null and void.

5.4 Fuse Replacement

1. Disconnect the AC power and remove the AC plug from the rear panel of the instrument.
2. Place a small screwdriver in the notch in the fuse holder cap, push in, and rotate 1/4 turn. The cap will pop out a few millimeters. Pull out the fuse holder cap and fuse, as shown in Figure 5-3.
3. Replace fuse by reversing process in step 1.

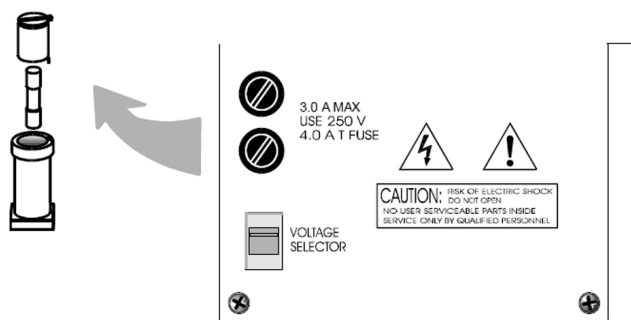

Figure 5-3: Removing Fuse Cap and Fuse from Holder

5.5 System Self Diagnostic Test

1. Press the *System* button to enter the system mode.
2. Use the ◀▶ arrow keys to move to *More*, and press *Enter*.
3. Use the ◀▶ arrow keys to move to *Self-Test*, and press *Enter*.

RUNNING DIAGNOSTIC

Testing Preamp — 83

During preamp testing there is a countdown in the lower right corner of the screen. When the testing is complete, the results are displayed.

Power: OK Analog: OK

Preamp: 3

The module is functioning properly if it is followed by OK. A number indicates a problem in a specific area of the instrument. Refer to Table 5-1 for number-code information. The results screen alternates for a time with:

Press Any Key

To Continue...

The following failure codes apply:

Table 5-1: Self Test Failure Codes

Power

0	OK
1	5 V Failure
2	15 V Failure
3	Both Failed

Analog

0	OK
1	DAC A (0–1 V Concentration)
2	DAC B (0–1 V Range ID)
3	Both Failed

Preamp

0	OK
1	Zero too high
2	Amplifier output doesn't match test input
3	Both Failed

5.6 Troubleshooting

Problem:

Erratic readings of the Oxygen concentration as reported by the analyzer.

Possible Cause:

The analyzer may have been calibrated in an inaccurate fashion.

Solution:

Turn the analyzer off, then back on again. Press the *System* key when prompted by the analyzer “Press System for default Values”. This will return the analyzer to its default settings in calibration and zero values. If erratic behavior continues replace the sensor.

Possible Cause:

Atmospheric Oxygen may be diffusing in through the vent and affecting the oxygen level which the sensor sees.

Solution:

Increase flow rate and/or length or vent tubing in order to dilute or minimize the diffusion of oxygen from the vent back to the sensor.

Problem:

Inaccurate zero operation (i.e. the user has zeroed the analyzer accidentally on gas much higher than one would normally use for a zero gas).

Solution:

Turn the analyzer off, then back on again. Press the **System** key when prompted by the analyzer "Press System for default Values". This will return the analyzer to its default settings in calibration and zero values. Now proceed to carefully calibrate and zero the analyzer.

Appendix

A-1 Model 3000TB Specifications

Packaging: NEMA-4, weather-proof, bulkhead mount.

Sensor: Insta Trace (B71875) Micro-Fuel Cell (std.) Other cells optional.

Cell Block: 316 stainless steel.

Ranges: Three user definable ranges from 0–10 ppm to 0–250,000 ppm, plus air calibration range of 0-250,000 ppm (25 %).

XL-Option Ranges: 0–1 ppm to 0–250,000 ppm, plus air calibration range of 0-250,000 ppm (25 %).
Autoranging with range ID output.

Sample System: Flow indicator visible from front of unit.
Positive pressure service.
Vacuum service (optional).
Auto Cal / Auto Zero. (Available with optional, electrically operated valves except XL option.)

Alarms: One system-failure alarm contact to detect power failure.
Two adjustable concentration threshold alarms with fully programmable setpoints.

Diagnostics: Start-up or on-demand, comprehensive, self testing function initiated by keyboard or remote command.

Displays: 2 line by 20 alphanumeric, VFD screen, and one 5 digit LED display.

Digital Interface: Full duplex RS-232 communications port.

Power: 110 or 220 VAC at 50 or 60 Hz.

Operating Temperature: 0-50 °C, XL option 5-35 °C

Accuracy: $\pm 2\%$ of full scale at constant temperature.
 $\pm 5\%$ of full scale over operating temperature range, on factory default analysis ranges, once thermal equilibrium has been achieved.

XL-Option Accuracy: ± 1 ppm on 0-10 ppm once thermal equilibrium is reached.
0-1 ppm range is $+0.2$ ppm once thermal equilibrium has been achieved.

Analog outputs: 0-1 VDC percent-of-range
0-1 VDC range ID.
4-20 mA DC percent-of-range, isolated
4-20 mA DC range ID, isolated

Password Access: Can be user-configured for password protection.

A-2 Recommended 2-Year Spare Parts List

Qty	Part Number	Description
1	62371B	Display PCB
1	D65295-A	Customer Interface PCB
1	C62368-A	Trace Preamplifier Board
1	C73870-B	Main Computer Board (4-20 mA Opt)
3	F 1295	Fuse, 4A, 250 V 5x20 mm Slow Blow
1	O38	O-ring
1	B71875	Insta Trace Micro-Fuel Cell (Std.)
1	C69367	3000T-XL Amplifier
1	C6689-B2CXL	B2CXL Micro-Fuel Cell (Option)
1	B66378	B2C Adapterfor Cell Block (Option)
1	A68729	Restrictor Kit

* See page iii for sensor used in this instrument

Note: Orders for replacement parts should include the part number (if available) and the model and serial number of the instrument for which the parts are intended.

Orders should be sent to:

TELEDYNE Analytical Instruments

16830 Chestnut Street

City of Industry, CA 91748

Phone (626) 934-1500, Fax (626) 961-2538

Web: www.teledyne-ai.com

or your local representative.

A-3 Drawing List

D66674 Outline Drawing

D66675 Wiring Diagram

Note: The MSDS on this material is available upon request through the Teledyne Environmental, Health and Safety Coordinator. Contact at (626) 934-1592.

A.4 Application Notes

3000 SERIES ANALYZERS

APPLICATION NOTES ON RESTRICTORS, PRESSURES AND FLOW RECOMMENDATIONS

The 3000 series analyzers require reasonably regulated sample pressures. While the 3000 analyzers are not sensitive to variations of incoming pressure provided they are properly vented to atmospheric pressure. The pressure must be maintained as to provide a useable flow rate through the analyzer. Any line attached to sample vent should be 1/4 or larger in diameter.

FLOW RATE RECOMMENDATIONS:

A usable flow rate for a 3000 series analyzer is one which can be measured on the flowmeter. This is basically .2-2.4 SLPM. The optimum flow rate is 1 SLPM (mid scale).

Note: Response time is dependent on flow rate, a low flow rate will result in slow response to O₂ changes in the sample stream. The span flow rate should be the approximately same as the sample flow rate.

CELL PRESSURE CONCERNS:

The sensors used in 3000 series analyzers are optimized to function at atmospheric pressure. At pressures other than atmospheric the diffusion rate of O₂ will be different than optimum value. Higher pressures will produce faster O₂ diffusion rates resulting in higher O₂ reading and shorter cell life. To use a 3000 series analyzer at a cell pressure other than atmospheric, the analyzer must be calibrated with a known calibration gas at the new cell pressure to adjust for the different diffusion rate. Cell pressures below 2/3 atmospheric are not recommended because they tend to cause excessive internal expansion which may result in seal failure.

For operation at cell pressures other than atmospheric, care must be taken not to change the sample pressure rapidly or cell damage may occur. For cell pressures above atmospheric, caution must be exercised to avoid over pressuring the cell holder. (Percent analyzers will require some type of cell retainer to prevent the cell from being pushed out by

the pressure). For operation at pressures below atmospheric pressure a suffix C (clamped) cell is required.

RESTRICTION DEVICES:

For proper operation, all 3000 series analyzers require a flow restriction device. This device is typically a restrictor or a valve. This restriction device serves two functions in the sample path. The first function is to limit the flow rate of the sample through the analyzer. A restrictor is chosen to operate over a range of pressures and provide a useable flow rate over that range.

The second function that the restriction device provides is a pressure drop. This device is selected to provide the only significant pressure drop in the sample path.

RESTRICTOR KIT

The current revision of the 3000 series analyzers are supplied with a kit containing two restrictors and a union which are user installed. These parts supplied to give the end user more flexibility when installing the analyzer. The restrictor kit is suitable for high and low positive pressure applications as well as vacuum service (atmospheric pressure sample) applications (see manual for installation instructions).

The standard restrictor (BLUE DOT) is recommended for pressures between 5 psig and 50 psig. For positive low pressure application (5 psig or less) the un-marked restrictor is better suited. For non-pressurized sample applications the marked restrictor should be used and configured for vacuum service.

For extremely low positive pressure applications (less than 2 psig) the vacuum service configuration should provide higher performance (higher flow rates). For vacuum service the end user must supply a vacuum pump and a bypass valve for the pump. A vacuum level of 5 - 10 inches of mercury should provide the optimum flow rate.

CAUTION: **FLOW RESTRICTORS HAVE VERY SMALL ORIFICES AND MAY BE PLUGGED BY SMALL PARTICLES (.005" DIA OR LARGER) A SAMPLE FILTER MUST BE INCLUDED IN THE SAMPLE LINE PRIOR TO THE RESTRICTOR! A 60 MICRON FILTER IS RECOMMENDED.**



3000TB EXAMPLES:

Example 1: With an incoming pressure of 10 psig the standard restrictor (blue dot) will provide a flow rate of 0.76 SLPM. Up-stream of the restrictor the sample line pressure will be 10 psig, while downstream (including the cell) the pressure will be at atmospheric pressure. (analyzer vented to atmospheric pressure) Note, all other pressure drops in the sample path are insignificant at these flowrates. This insures that the cell operates at atmospheric pressure. At very high flow rates (off scale of flow-meter), pressure drops other than the restriction device could become significant, and result in pressurizing the cell.

Example 2: A 3000TB is configured for vacuum service as follows. The un-marked restrictor is placed in the sample vent port. The downstream end of the restrictor is then connected to a vacuum pump and bypass valve. The bypass valve is adjusted to provide a flow rate of 1 SLPM. The sample pressure between the pump and the restrictor will be approximately -7 inches of mercury, while the pressure in the balance of the sample system including the cell will be approximately at atmospheric pressure. (Provided the sample flow into the analyzer is not blocked.)

BYPASS:

To improve the system response, a bypass can be added to increase the sample flow rate to the analyzer by a factor of ten. A bypass provides a sample flow path around the analyzer of 2-18 scfh, typically.

CALIBRATION GAS:

For 3000 series analyzers r with the Auto-Cal option, the customer must supply control valves (or restrictors) for any SPAN or ZERO gas source which is attached to the Auto-Cal ports. The valve should be adjusted to the same flow rate as the sample gas. When restrictors are used, the gas pressure must be adjusted to achieve the proper flow rate.

OPERATION WITHOUT A RESTRICTOR DEVICE:

Operation without a restrictor device is not recommend as mentioned above. A 3000TB without any flow restrictor device was tested on 11-19-97. This results in a flow rate of 2.4 slpm at 1 psig. This is a cv of 0.023 for the standard sample system.

REFERENCE: FLOW_1 .XLS & FLOW_2.XLS for information on flow rates at various pressures.

TAI PART NUMBERS

Restrictor Kit:	A68729	
Union (ss)	U11	
LP. Restrictor	R2323	(low pressure /vac. service)
Std. Restrictor	R2324	Blue Dot
Nut	N73	
Ferrule	F73	
Ferrule	F74	Both ferrules are required

CONVERSIONS:

1 PSI = 2.04 INCHES OF MERCURY (in. Hg.)
1 SCFH = 0.476 SLPM

A-5 Material Safety Data Sheet

Section I - Product Identification

Product Name: Micro-fuel Cells
 Mini-Micro-fuel Cells
 Super Cell, all classes except T-5F
 Electrochemical Oxygen Sensors, all classes

Manufacturer: Teledyne Electronic Technologies
 Analytical Instruments

Address: 16380 Chestnut Street,
 City of Industry, CA 91749

Phone: (626) 961-9221

Technical Support: (626) 934-1673

Environment, Health and Safety: (626) 934-1592

Date Prepared: 11/23/98

Section II - Physical and Chemical Data

Chemical and Common Names:	Potassium Hydroxide (KOH), 15% (w/v) Lead (Pb), pure	
CAS Number:	KOH 1310-58-3 Pb 7439-92-1	
	KOH (15% w/v)	Pb (pure)
Melting Point/Range:	-10 to 0 °C	328 °C
Boiling Point/Range:	100 to 115 °C	1744 °C
Specific Gravity:	1.09 @ 20 °C	11.34
pH:	>14	N/A
Solubility in Water:	Completely soluble	Insoluble
Percent Volatiles by Vol.:	None	N/A
Appearance and Odor:	Colorless, odorless solution	Grey metal, odorless

Section III -Physical Hazards

Potential for fire and explosion: The electrolyte in the Micro-fuel Cells is not flammable. There are no fire or explosion hazards associated with Micro-fuel Cells.

Potential for reactivity: The sensors are stable under normal conditions of use. Avoid contact between the sensor electrolyte and strong acids.

Section IV - Health Hazard Data

Primary route of entry: Ingestion, eye/skin contact

Exposure limits: OSHA PEL: 0.05 mg./cu.m. (Pb)

ACGIH TLV: 2 mg/ cu.m. (KOH)

Effects of overexposure

Ingestion: The electrolyte could be harmful or fatal if swallowed.

Oral LD50 (RAT) = 3650 mg/kg

Eye: The electrolyte is corrosive; eye contact could result in permanent loss of vision.

Dermal: The electrolyte is corrosive; skin contact could result in a chemical burn.

Inhalation: Liquid inhalation is unlikely.

Signs/symptoms of exposure: Contact with skin or eyes will cause a burning sensation and/or feel soapy or slippery to touch.

Medical conditions aggravated by exposure: None

Carcinogenicity: NTP Annual Report on Carcinogens: Not listed

LARC Monographs: Not listed

OSHA: Not listed

Other health hazards: Lead is listed as a chemical known to the State of California to cause birth defects or other reproductive harm.

Section V - Emergency and First Aid Procedures

Eye Contact: Flush eyes with water for at least 15 minutes and get immediate medical attention.

Skin Contact: Wash affected area with plenty of water and remove contaminated clothing. If burning persists, seek medical attention.

Ingestion: Give plenty of cold water. Do not induce vomiting. Seek medical attention. Do not administer liquids to an unconscious person.

Inhalation: Liquid inhalation is unlikely.

Section VI - Handling Information

NOTE: The oxygen sensors are sealed, and under normal circumstances, the contents of the sensors do not present a health hazard. The following information is given as a guide in the event that a cell leaks.

Protective clothing: Rubber gloves, chemical splash goggles.

Clean-up procedures: Wipe down the area several times with a wet paper towel. Use a fresh towel each time.

Protective measures during cell replacement: Before opening the bag containing the sensor cell, check the sensor cell for leakage. If the sensor cell leaks, do not open the bag. If there is liquid around the cell while in the instrument, put on gloves and eye protection before removing the cell.

Disposal: Should be in accordance with all applicable state, local and federal regulations.

NOTE: The above information is derived from the MSDS provided by the manufacturer. The information is believed to be correct but does not purport to be all inclusive and shall be used only as a guide. Teledyne Analytical Instruments shall not be held liable for any damage resulting from handling or from contact with the above product.

NOTES: UNLESS OTHERWISE SPECIFIED.

- 1 INTERCONNECTION DIAGRAM: DWG# D-66677
- 2 WIRING DIAGRAM ASSEMBLY: DWG D-66675
TRACE SERIES: DWG D-66826
PERCENT SERIES: DWG D-66826
- 3 FINAL ASSEMBLY:
TRACE SERIES: DWG D-66673
PERCENT SERIES: DWG D-66882

4. (a). UNIT: INCHES[mm]
- (b). ALL DIMENSIONS IN INCHES (±.06) AND MILLIMETERS (±1.)

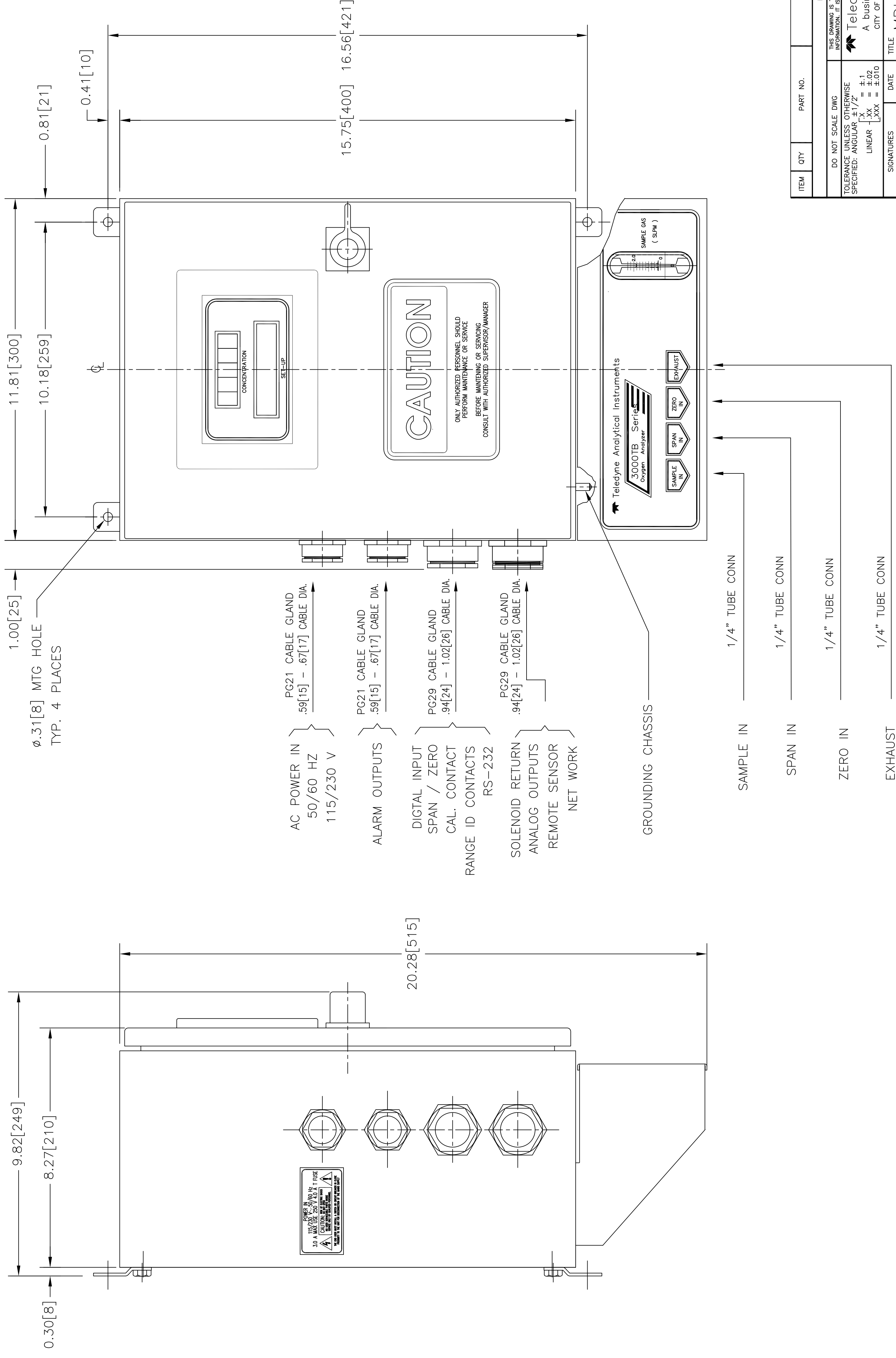

REV	DESCRIPTION	DATE	APP.	REV.
0	ECO# 96-550	7-29-96	B.T.	BT

ITEM	QTY	PART NO.	DESCRIPTION
BILL OF MATERIAL			
DO NOT SCALE DWG TOLERANCE UNLESS OTHERWISE SPECIFIED: ANGULAR ±1/2° LINEAR ±.02 XXX ±.010			
THIS DRAWING IS THE PROPERTY OF TELEDYNE ANALYTICAL INSTRUMENTS AND CONTAINS CONFIDENTIAL INFORMATION. IT IS NOT TO BE COPIED, REPRODUCED OR USED WITHOUT WRITTEN PERMISSION.			
Teledyne Analytical Instruments A business unit of Teledyne Electronic Technologies CITY OF INDUSTRY, CALIFORNIA 91748			
SIGNATURES			SCALE 1/2
DRAFT: BILL TARRNG	DATE: 06-03-96	MDL 3000TB / 3000PB	
CHK:		OXYGEN ANALYZER	
APPR: WILLIAM TARRNG		OUTLINE DIAGRAM	
ENGR:		SHEET 1 OF 1	
S.O.:		REV. 0	
REFERENCE:		Dwg. No. D-66674	

1 2 3 4 5 6 7 8

1 2 3 4 5 6 7 8

NOTES: UNLESS OTHERWISE SPECIFIED.

- 1 ITEM 2 IS FOR CONTROL VALVE OPTION ONLY.
- 2 ITEM 5 (35 PIN RIBBON CABLE), 6 (14 PIN RIBBON CABLE) & 7 (60 PIN RIBBON CABLE) TO BE ROUTED BETWEEN ISOLATION SHEET (P/N B66878) AND PCB MOUNTING BRACKET (P/N B66678).
- 3 TRY TO KEEP WIRING AWAY FROM HEAT SINKS.

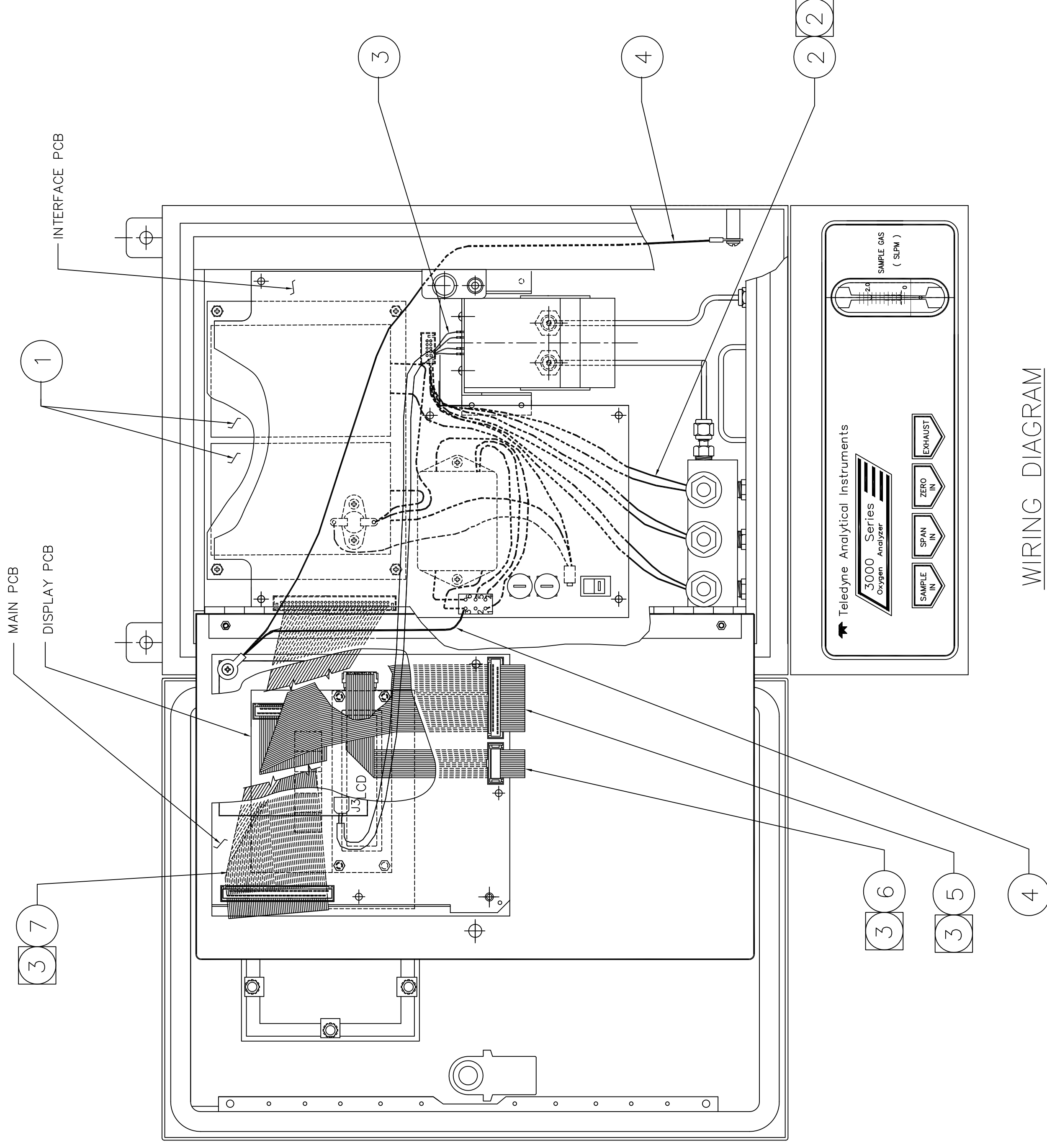

WIRING DIAGRAM
DOOR OPENED

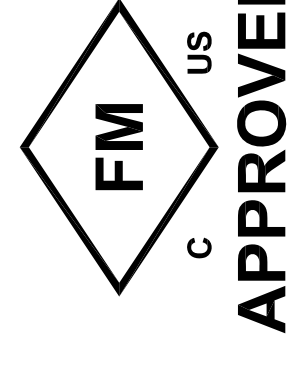

REV	DESCRIPTION	DATE	APP.	REV. BY
1	INC. ECO# 97-0221	3-25-97	R.N.	VF
2	INC. ECO# 99-0007	1/26/99	A.A.	M.V.
3	INC ECO 07-0039	1/29/07	AA	VF

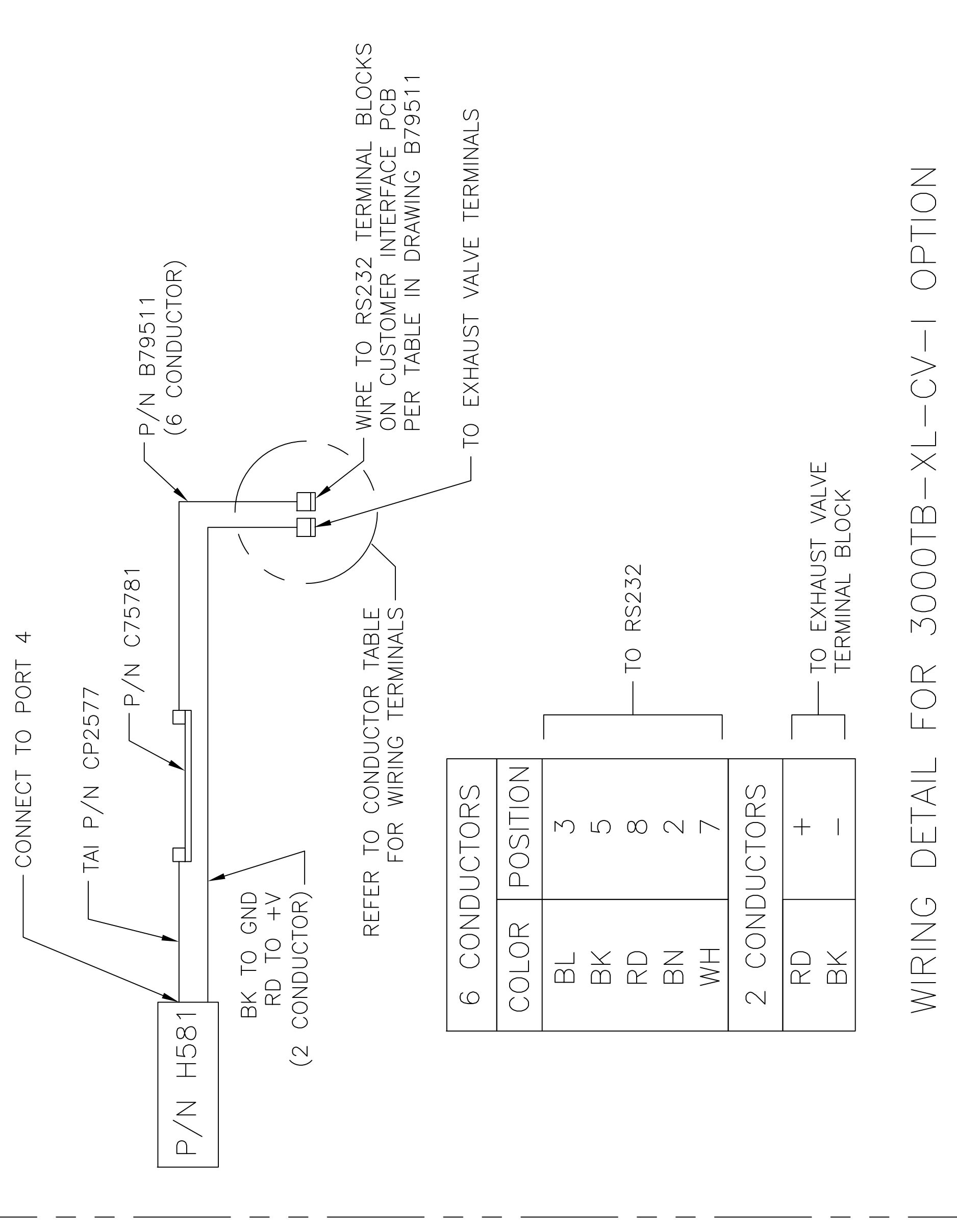

6 CONDUCTORS	
COLOR	POSITION
BL	3
BK	5
RD	8
BN	2
WH	7

2 CONDUCTORS	
COLOR	POSITION
RD	+
BK	-

WIRING DETAIL FOR 3000TB-XL-CV-I OPTION

ITEM	QTY	PART NO.	DESCRIPTION
7	REF	B-66876	RIBBON CABLE ASSY (MAIN PCB - CUSTOMER INTERFACE PCB)
6	REF	B-66828	RIBBON CABLE ASSY (MAIN PCB - LCD PCB)
5	REF	B-66829	RIBBON CABLE ASSY (MAIN PCB - DISPLAY PCB)
4	REF	B-66877	EMI FILTER & GROUNDING WIRING ASSY
3	REF	B-65917	WIRING ASSY (SENSOR BLOCK - PREAMP PCB)
2	REF	B-65915	WIRING ASSY (CONTROL VALVES - CUSTOMER INTERFACE PCB)
1	REF	B-67446	WIRING ASSY (HEATER TO CUSTOMER INTERFACE PCB)

BILL OF MATERIAL	
DO NOT SCALE DWG	THIS DRAWING IS THE PROPERTY OF TELEDYNE INSTRUMENTS AND CONTAINS CONFIDENTIAL INFORMATION. IT IS NOT TO BE COPIED, REPRODUCED OR USED WITHOUT WRITER'S PERMISSION.
TOLERANCE UNLESS OTHERWISE SPECIFIED: ANGULAR ±1/2°	TELEDYNE INSTRUMENTS
LINEAR .XXX = ±.02	Analytical Instruments
.XXX = ±.010	A Teledyne Technologies Company
	CITY OF INDUSTRY, CALIFORNIA 91748
SIGNATURES	DATE
DRAFT: BILL TARNIG	6-26-96
CHK:	
APPR: B. TARNIG	7-29-96
ENGR: WILLIAM TARNIG	
C.O.	
REFERENCE: CAD ID: D66675-3	
TITLE	SCALE
WIRING DIAGRAM	1/2
OXYGEN ANALYZER	SIM
MODEL 3000TB/PB	SHEET 1 OF 1
MATL: - LISTED -	DWG NO: D-66675
	REV: 3

